

D
ARAGONTM
IMPLANT COMPANY



GENSTM

GENS+TM

NIZPLANTTM

MEET DR. NIZNICK CEO OF PARAGON IMPLANT™ COMPANY

“One purpose: Making implant dentistry more accessible to the patient and more predictable for the clinician.”

- GERALD NIZNICK, DMD, MSD



TABLE OF CONTENTS

IMPLANTS

Implant Dimensions & Labeling.....	4-9
GEN5™, GEN5+™ & NizPlant™ Implants.....	10-15
GEN5 and GEN5+ Implant Carrier Packaging.....	16-17
Selection Chart.....	18-19

PROSTHETICS

Cover Screws, Healing Abutments & Transfers.....	20-21
Implant Analogs, Straight & Angled Contour Abutments.....	22-23
Titanium Temporary, PEEK Temporary & Angled Screw Channel Abutments.....	24-25
Multi-Unit Abutments & Prosthetic Components.....	26-27
NizLoc Abutments, Extenders & Components & Fixation Screws.....	28-29

INSTRUMENTS

Surgical Drills & Drill Sequence.....	30-31
Step Drill Depth Markings & Crestal Bone Drills & Cortical Bone Drill Sequence.....	32-33
Surgical Tray.....	34-35
Drill Stops & Drill Stop Sequence and Placement.....	36-37
Prosthetic Tray & Tooling.....	38-41

THE NEXT GENERATION

GEN5™

Two Platforms

Color-coded internal-hex conical connections

Smooth Neck with Gauge Lines

Accommodate uneven ridges and immediate extraction sites by varying insertion depth

Cutting Grooves

Two full-length, self-tapping cutting grooves

Straight Neck

Crestal bone seal and increased stability

Progressive Thread Depth

Double-lead, reverse buttress threads for increased bone contact

Tapered Body

Tapered body for increased initial stability

Restorative Flexibility

Friction-Fit extender can be converted to standard MUA, Overdenture Abutment or a variety of Abutment Options

Straight Neck

Crestal bone seal and increased stability

Progressive Thread Depth

Double-lead, reverse buttress threads for increased bone contact

Tapered Body

Tapered body for increased initial stability

GEN5+™

Dual-Function

Platform can function as an overdenture or a multi-unit abutment

Straight Neck

Crestal bone seal and increased stability

Progressive Thread Depth

Double-lead, reverse buttress threads for increased bone contact

Tapered Body

Tapered body for increased initial stability

Compatible Platform

External wall provides Locator® compatible platform*

Smooth Neck with Gauge Lines

Accommodate uneven ridges and immediate extraction sites by varying insertion depth

Cutting Grooves

Two full-length, self-tapping cutting grooves

NIZPLANT™

GEN5™ DIMENSIONS

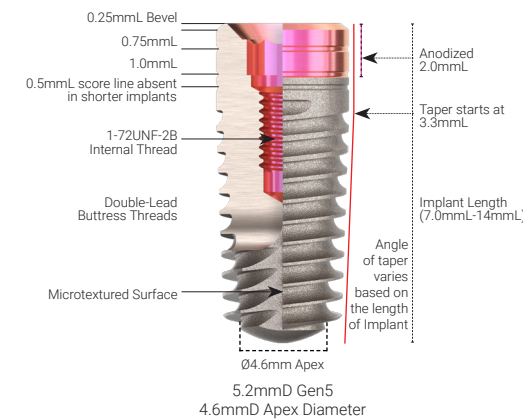
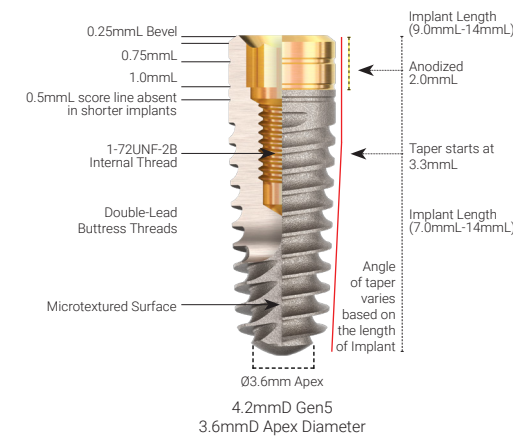
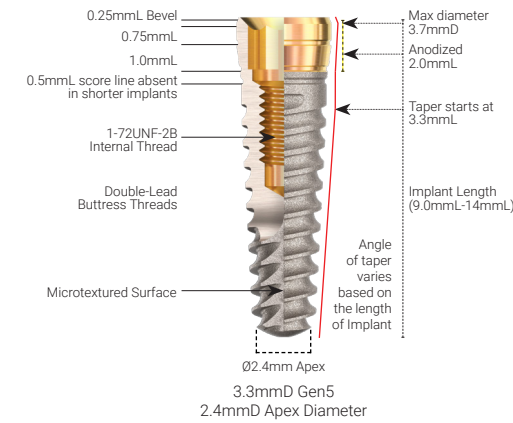

Ø3.5mm Implant Platform Ø3.3mmD Body

3.5mmD Prosthetic Platform incorporates a standard 2.5mmD Internal Hex configuration having a depth of 1.9mmL from top of Implant Platform.

Ø3.5mm Implant Platform Ø3.7mmD Body

Both 4.5mmD and 3.5mmD Prosthetic Platforms incorporate a standard 2.5mmD Internal Hex configuration having a depth of 1.9mmL from top of Implant Platform.

Ø3.5mm Implant Platform Ø4.2mmD Body

Both 4.5mmD and 3.5mmD Prosthetic Platforms incorporate a standard 2.5mmD Internal Hex configuration having a depth of 1.9mmL from top of Implant Platform.

Ø4.5mm Implant Platform Ø4.7mmD Body

4.5mmD Prosthetic Platform incorporates a standard 2.5mmD Internal Hex configuration having a depth of 1.9mmL from top of Implant Platform.

Ø4.5mm Implant Platform Ø5.2mm Body

4.5mmD Prosthetic Platform incorporates a standard 2.5mmD Internal Hex configuration having a depth of 1.9mmL from top of Implant Platform.

Ø4.5mm Implant Platform Ø5.7mm Body

4.5mmD Prosthetic Platform incorporates a standard 2.5mmD Internal Hex configuration having a depth of 1.9mmL from top of Implant Platform.

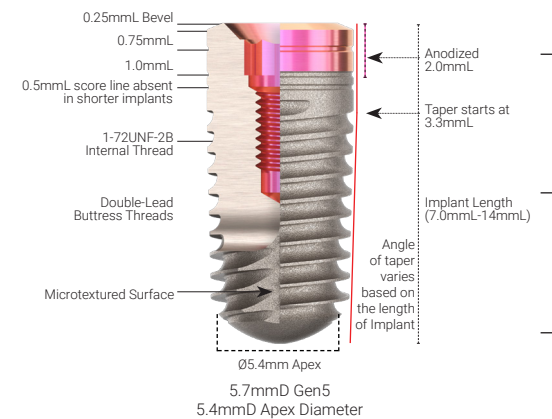
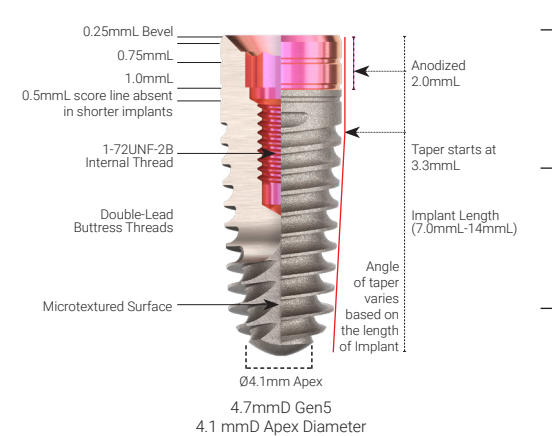
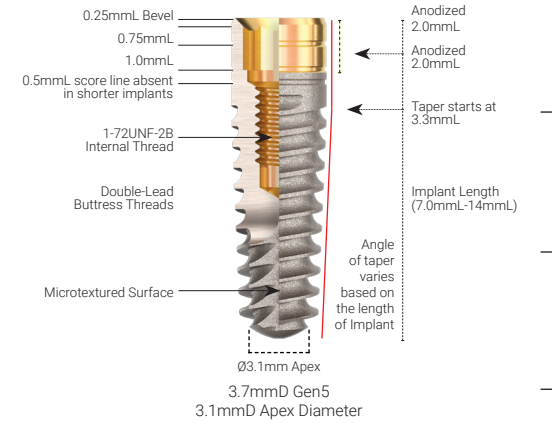

IMPLANT DIMENSIONS & LABELING
GEN5™ & NIZPLANT™
IMPLANT CARRIER PACKAGING
SELECTION CHART
HEALING COLLARS & TRANSFERS
ANALOGS & STRAIGHT/ ANGLED
TEMPORARY & ASC
MUA & COMPONENTS
NIZLOC & SCREWS
SURGICAL DRILLS & SEQUENCE
STEP DRILL DEPTH MARKINGS
SURGICAL TRAY
PROSTHETIC TRAY & TOOLING
DRILL STOPS

GEN5+™ DIMENSIONS

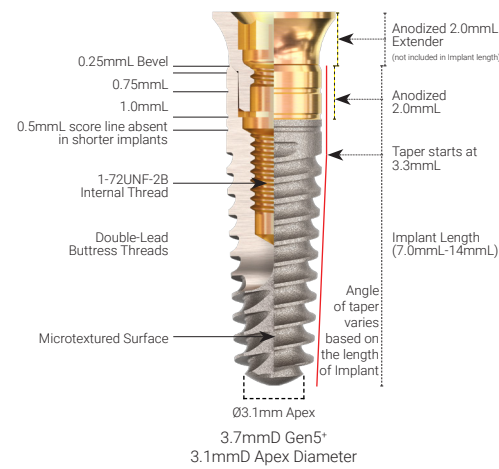
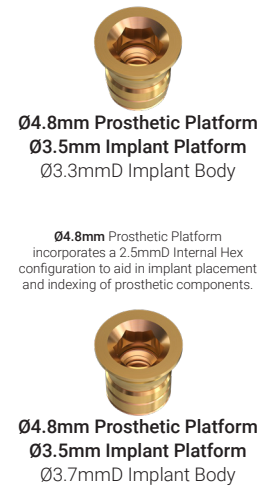
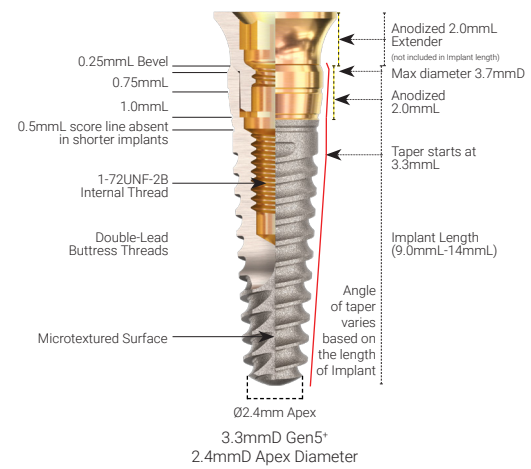

NIZPLANT™ DIMENSIONS

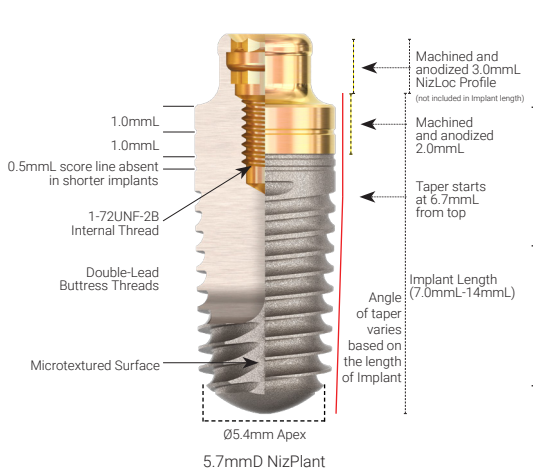
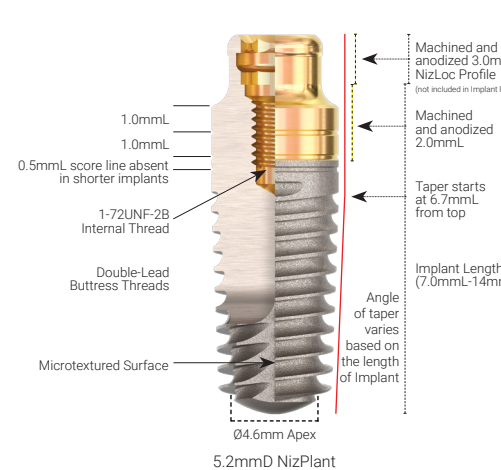
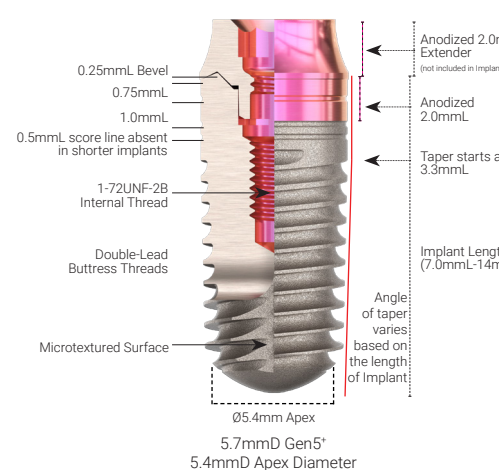
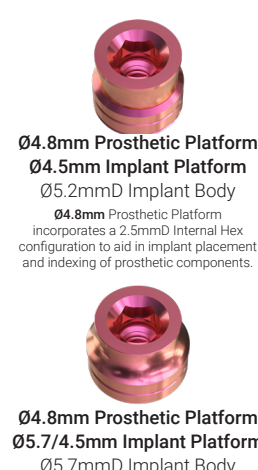
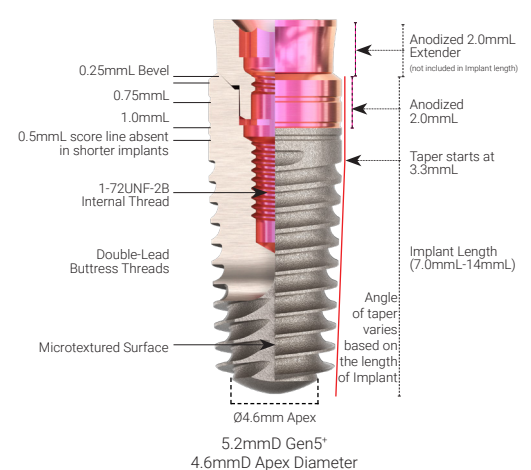
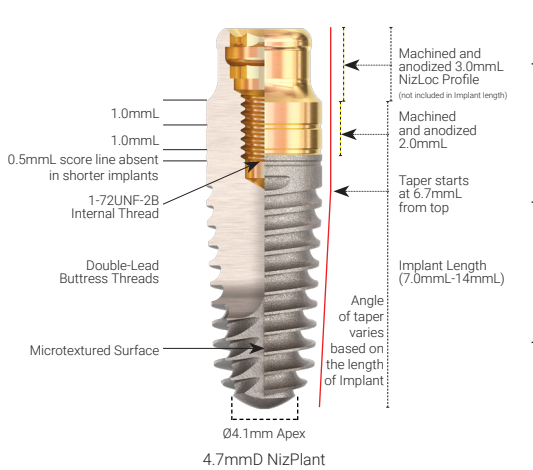
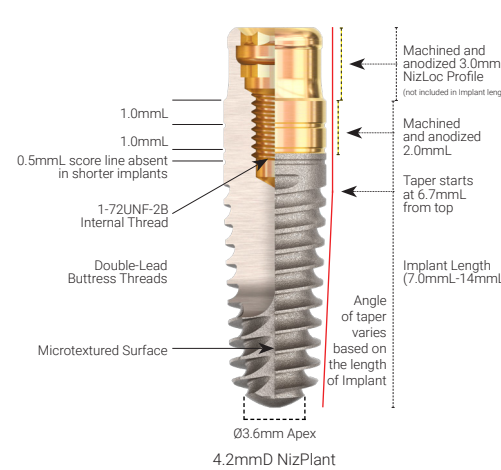
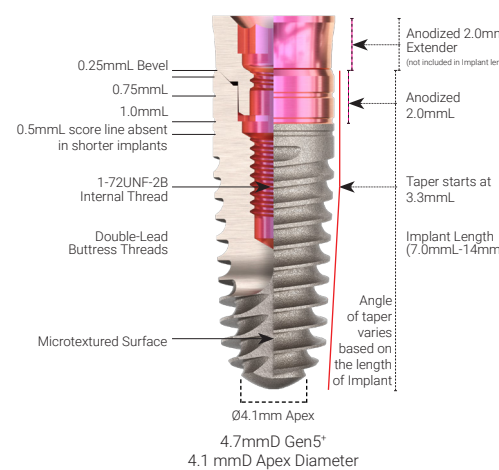
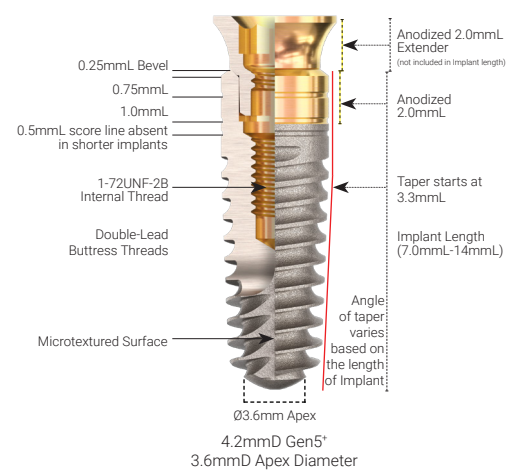
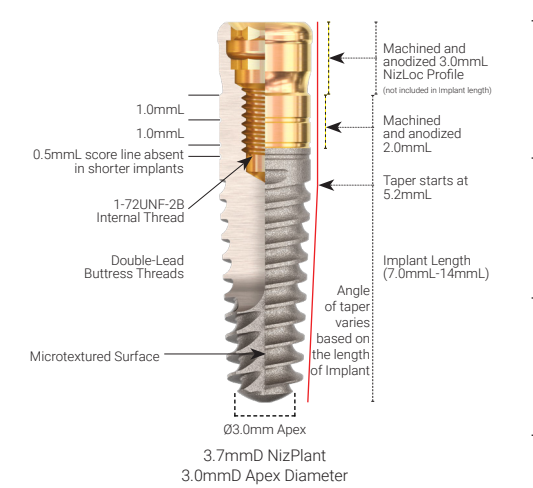
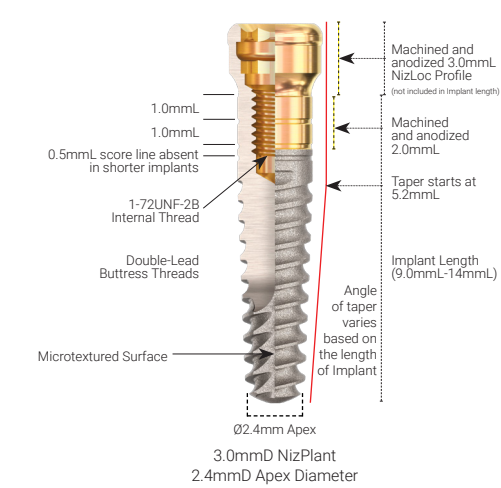

- IMPLANT DIMENSIONS & LABELING
- GEN5+™ & NIZPLANT™
- IMPLANT CARRIER & PACKAGING
- SELECTION CHART
- HEALING COLLARS & TRANSFERS
- ANALOGS & STRAIGHT/ ANGLED
- TEMPORARY & ASC
- MU & COMPONENTS
- NIZLOC & SCREWS
- SURGICAL SEQUENCE
- STEP DRILL DEPTH MARKINGS
- SURGICAL TRAY
- PROSTHETIC TRAY & TOOLING
- DRILL STOPS

MANUFACTURING FACILITY



Paragon's™ Manufacturing and Administration building was constructed by Dr. Niznick in 1994 for Core-Vent. It became the home of Zimmer Dental (2001-2004), Implant Direct® (2004-2010) and Implant Direct Sybron (2011-2014). The building now houses 25 CNC machines equipped with state-of-the-art technology to allow lights-out manufacturing. In addition, it has a Class 10,000 cleanroom for packaging and a department for applying surface treatments including anodizing and blasting.

Due to the small size of the implants and abutments, the stability and precision of the connection is critical to prevent complications, such as screw loosening or fracture. To meet these demanding requirements, Paragon has invested heavily in advanced manufacturing technology, including custom-designed cutting and inspection tools and precision gages. These tools complement our state-of-the-art quality department and give us total control over the manufacturing process.

Our CNC screw machines are integrated with the cutting-edge Caron process monitoring system, enabling continuous, lights out 24/6 production with minimal human intervention. This level of automation dramatically reduces production costs while ensuring every component meets our exceptionally tight tolerance specifications.

As a result, Paragon can offer implants at a price equivalent to what Dr. Niznick charged in 1990—while delivering innovative, American-made products. This combination of product innovation, precision engineering and highly competitive pricing will differentiate Paragon from its competitors, while making implant dentistry more affordable for patients and more profitable for dentists.

LABELING

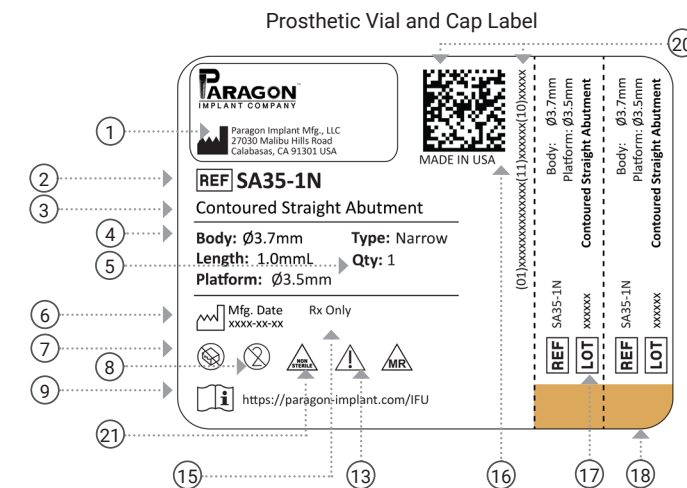
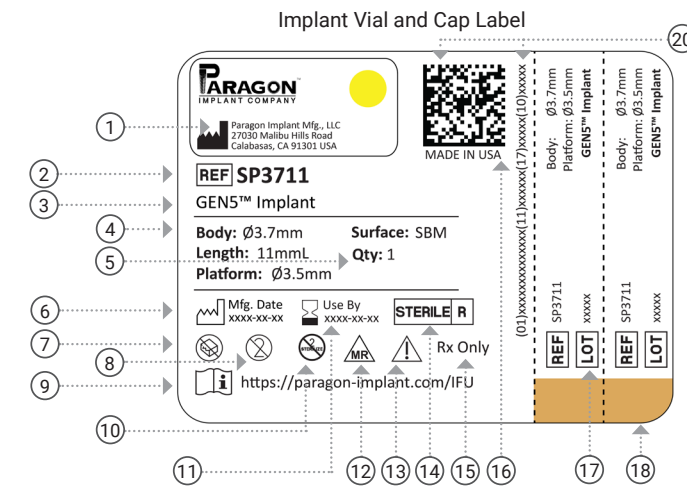

- | | |
|--|--|
| 1) Manufacturer symbol | 12) MR Conditional symbol |
| 2) Product code or reference number | 13) Caution / Warning See IFU |
| 3) Product description | 14) Sterilized using gamma irradiation symbol |
| 4) Product dimensions | 15) Caution: US law restricts the sale of these devices by or on the order of a dentist or physician |
| 5) Item quantity | 16) Country of origin |
| 6) Manufacture date (XXXX-XX-XX) | 17) Lot number (XXXXXX) |
| 7) Tamper proof symbol | 18) Implant body diameter color reference |
| 8) Do not re-use symbol | 19) Implant prosthetic platform diameter (color-coded) |
| 9) Refer to Instructions For Use (IFU) | 20) Unique Device Identification (UDI) barcode and text |
| 10) Do not resterilize symbol | 21) Sold Non-Sterile symbol |
| 11) Use by date (XXXX-XX-XX) | |

IMPLANT DIMENSIONS & LABELING
 GENS™ & NIZPLANT™
 IMPLANT CARRIER PACKAGING
 SELECTION CHART
 HEALING COLLARS & TRANSFERS
 ANALOGS & STRAIGHT/ ANGLED
 TEMPORARY & ASC
 MUA & COMPONENTS
 NIZLOC & SCREWS
 SURGICAL DRILLS & SEQUENCE
 STEP DRILL DEPTH MARKINGS
 SURGICAL TRAY
 PROSTHETIC TRAY & TOOLING
 DRILL STOPS

GEN5™



Uneven ridge dips 1.5mm from lingual to buccal
Placement 1mm supracrestal
Placement bone-level, lingual side

Industry Standard 45° lead-in Conical Connection (Niznick US Patent #4,960,381) maximizes wall thickness on narrow implants

Two Platform Diameters (3.5mmD & 4.5mmD) optimize emergence profile

1mm added to the standard lengths provides vertical flexibility for placement in uneven ridges and extraction sockets



3.3mmD	Code	Platform	Diameter	Length	Price
*Max diameter 3.7mmD	SP3309	3.5mmP	3.3mmD	9mmL	\$125
	SP3311	3.5mmP	3.3mmD	11mmL	\$125
	SP3312	3.5mmP	3.3mmD	12mmL	\$125
	SP3314	3.5mmP	3.3mmD	14mmL	\$125

SP3309 SP3311 SP3312 SP3314

3.7mmD	Code	Platform	Diameter	Length	Price
	SP3707	3.5mmP	3.7mmD	7mmL	\$125
	SP3709	3.5mmP	3.7mmD	9mmL	\$125
	SP3711	3.5mmP	3.7mmD	11mmL	\$125
	SP3712	3.5mmP	3.7mmD	12mmL	\$125
	SP3714	3.5mmP	3.7mmD	14mmL	\$125

SP3707 SP3709 SP3711 SP3712 SP3714

4.2mmD	Code	Platform	Diameter	Length	Price
	SP4207	3.5mmP	4.2mmD	7mmL	\$125
	SP4209	3.5mmP	4.2mmD	9mmL	\$125
	SP4211	3.5mmP	4.2mmD	11mmL	\$125
	SP4212	3.5mmP	4.2mmD	12mmL	\$125
	SP4214	3.5mmP	4.2mmD	14mmL	\$125

SP4207 SP4209 SP4211 SP4212 SP4214

4.7mmD	Code	Platform	Diameter	Length	Price
	WP4707	4.5mmP	4.7mmD	7mmL	\$125
	WP4709	4.5mmP	4.7mmD	9mmL	\$125
	WP4711	4.5mmP	4.7mmD	11mmL	\$125
	WP4712	4.5mmP	4.7mmD	12mmL	\$125
	WP4714	4.5mmP	4.7mmD	14mmL	\$125

WP4707 WP4709 WP4711 WP4712 WP4714

5.2mmD	Code	Platform	Diameter	Length	Price
	WP5207	4.5mmP	5.2mmD	7mmL	\$125
	WP5209	4.5mmP	5.2mmD	9mmL	\$125
	WP5211	4.5mmP	5.2mmD	11mmL	\$125
	WP5212	4.5mmP	5.2mmD	12mmL	\$125
	WP5214	4.5mmP	5.2mmD	14mmL	\$125

WP5207 WP5209 WP5211 WP5212 WP5214

5.7mmD	Code	Platform	Diameter	Length	Price
	WP5707	4.5mmP	5.7mmD	7mmL	\$125
	WP5709	4.5mmP	5.7mmD	9mmL	\$125
	WP5711	4.5mmP	5.7mmD	11mmL	\$125
	WP5712	4.5mmP	5.7mmD	12mmL	\$125
	WP5714	4.5mmP	5.7mmD	14mmL	\$125

WP5707 WP5709 WP5711 WP5712 WP5714

IMPLANT DIMENSIONS & LABELING
 GEN5™ & NIZLOC™
 IMPLANT CARRIER PACKAGING
 SELECTION CHART
 HEALING COLLARS & TRANSFERS
 ANALOGS & STRAIGHT/ ANGLED
 TEMPORARY & ASC
 MUA & COMPONENTS
 NIZLOC & SCREWS
 SURGICAL DRILLS & SEQUENCE
 STEP DRILL DEPTH MARKINGS
 SURGICAL TRAY
 PROSTHETIC TRAY & TOOLING
 DRILL STOPS

GEN5+™

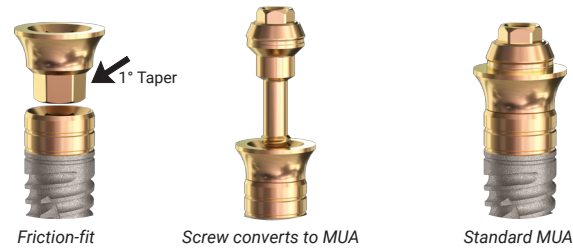

Detachable 2mm friction-fit extender for 1-Stage Surgery, simplifies restorative procedures by elevating platform

Extender can be removed to allow prosthetic connection to the implant platform for esthetics if tissue recedes

Attachment of application-specific prosthetic screws converts platform to standard MUA or a variety of other abutment options



3.3mmD	Code	Platform	Diameter	Length	Price
*Max diameter 3.7mmD 	NSP3309	4.8mmP	3.3mmD	9mmL	\$150
	NSP3311	4.8mmP	3.3mmD	11mmL	\$150
	NSP3312	4.8mmP	3.3mmD	12mmL	\$150
	NSP3314	4.8mmP	3.3mmD	14mmL	\$150

3.7mmD	Code	Platform	Diameter	Length	Price
	NSP3707	4.8mmP	3.7mmD	7mmL	\$150
	NSP3709	4.8mmP	3.7mmD	9mmL	\$150
	NSP3711	4.8mmP	3.7mmD	11mmL	\$150
	NSP3712	4.8mmP	3.7mmD	12mmL	\$150
	NSP3714	4.8mmP	3.7mmD	14mmL	\$150

4.2mmD	Code	Platform	Diameter	Length	Price
	NSP4207	4.8mmP	4.2mmD	7mmL	\$150
	NSP4209	4.8mmP	4.2mmD	9mmL	\$150
	NSP4211	4.8mmP	4.2mmD	11mmL	\$150
	NSP4212	4.8mmP	4.2mmD	12mmL	\$150
	NSP4214	4.8mmP	4.2mmD	14mmL	\$150

4.7mmD	Code	Platform	Diameter	Length	Price
	NWP4707	4.8mmP	4.7mmD	7mmL	\$150
	NWP4709	4.8mmP	4.7mmD	9mmL	\$150
	NWP4711	4.8mmP	4.7mmD	11mmL	\$150
	NWP4712	4.8mmP	4.7mmD	12mmL	\$150
	NWP4714	4.8mmP	4.7mmD	14mmL	\$150

5.2mmD	Code	Platform	Diameter	Length	Price
	NWP5207	4.8mmP	5.2mmD	7mmL	\$150
	NWP5209	4.8mmP	5.2mmD	9mmL	\$150
	NWP5211	4.8mmP	5.2mmD	11mmL	\$150
	NWP5212	4.8mmP	5.2mmD	12mmL	\$150
	NWP5214	4.8mmP	5.2mmD	14mmL	\$150

5.7mmD	Code	Platform	Diameter	Length	Price
	NWP5707	4.8mmP	5.7mmD	7mmL	\$150
	NWP5709	4.8mmP	5.7mmD	9mmL	\$150
	NWP5711	4.8mmP	5.7mmD	11mmL	\$150
	NWP5712	4.8mmP	5.7mmD	12mmL	\$150
	NWP5714	4.8mmP	5.7mmD	14mmL	\$150

IMPLANT DIMENSIONS & LABELING

GEN5+™ & NIZLOC™

IMPLANT CARRIER PACKAGING

SELECTION CHART

HEALING COLLARS & TRANSFERS

ANALOGS & STRAIGHT/ ANGLED

TEMPORARY & ASC

MUA & COMPONENTS

NIZLOC & SCREWS

SURGICAL DRILLS & SEQUENCE

STEP DRILL DEPTH MARKINGS

SURGICAL TRAY

PROSTHETIC TRAY & TOOLING

DRILL STOPS

NIZPLANT™

*Locator is a registered trademark of Zest IP Holdings



NizLoc engages both the inside and the outside of the platform

Screw Removed

Fixed Bridge

1-piece implant with a dual-function platform that allows it to be used to initially retain an overdenture, and then be converted to a full-arch fixed restoration

NizPlant™ has a 45° lead-in bevel, internal hex, and internal threads for attachment of a fixed full-arch hybrid restoration

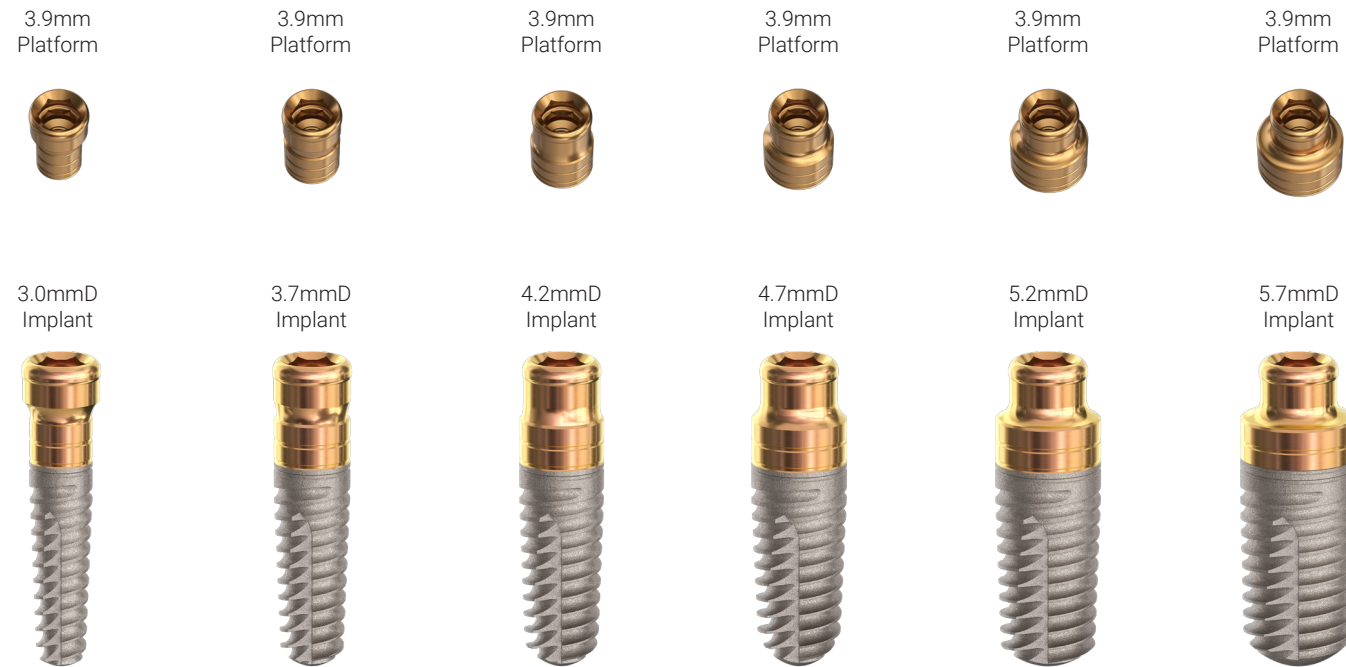

3.0mmD	Code	Platform	Diameter	Length	Price
	NP3009	3.9mmP	3.0mmD	9mmL	\$135
	NP3011	3.9mmP	3.0mmD	11mmL	\$135
	NP3012	3.9mmP	3.0mmD	12mmL	\$135
	NP3014	3.9mmP	3.0mmD	14mmL	\$135

3.7mmD	Code	Platform	Diameter	Length	Price
	NP3707	3.9mmP	3.7mmD	7mmL	\$135
	NP3709	3.9mmP	3.7mmD	9mmL	\$135
	NP3711	3.9mmP	3.7mmD	11mmL	\$135
	NP3712	3.9mmP	3.7mmD	12mmL	\$135
	NP3714	3.9mmP	3.7mmD	14mmL	\$135

4.2mmD	Code	Platform	Diameter	Length	Price
	NP4207	3.9mmP	4.2mmD	7mmL	\$135
	NP4209	3.9mmP	4.2mmD	9mmL	\$135
	NP4211	3.9mmP	4.2mmD	11mmL	\$135
	NP4212	3.9mmP	4.2mmD	12mmL	\$135
	NP4214	3.9mmP	4.2mmD	14mmL	\$135

4.7mmD	Code	Platform	Diameter	Length	Price
	NP4707	3.9mmP	4.7mmD	7mmL	\$135
	NP4709	3.9mmP	4.7mmD	9mmL	\$135
	NP4711	3.9mmP	4.7mmD	11mmL	\$135
	NP4712	3.9mmP	4.7mmD	12mmL	\$135
	NP4714	3.9mmP	4.7mmD	14mmL	\$135

5.2mmD	Code	Platform	Diameter	Length	Price
	NP5207	3.9mmP	5.2mmD	7mmL	\$135
	NP5209	3.9mmP	5.2mmD	9mmL	\$135
	NP5211	3.9mmP	5.2mmD	11mmL	\$135
	NP5212	3.9mmP	5.2mmD	12mmL	\$135
	NP5214	3.9mmP	5.2mmD	14mmL	\$135

5.7mmD	Code	Platform	Diameter	Length	Price
	NP5707	3.9mmP	5.7mmD	7mmL	\$135
	NP5709	3.9mmP	5.7mmD	9mmL	\$135
	NP5711	3.9mmP	5.7mmD	11mmL	\$135
	NP5712	3.9mmP	5.7mmD	12mmL	\$135
	NP5714	3.9mmP	5.7mmD	14mmL	\$135

IMPLANT DIMENSIONS & LABELING
 GENS™ & NIZPLANT™
 IMPLANT CARRIER PACKAGING
 SELECTION CHART
 HEALING COLLARS & TRANSFERS
 ANALOGS & STRAIGHT/ ANGLED
 TEMPORARY & ASC
 MUA & COMPONENTS
 NIZLOC & SCREWS
 SURGICAL DRILLS & SEQUENCE
 STEP DRILL DEPTH MARKINGS
 SURGICAL TRAY
 PROSTHETIC TRAY & TOOLING
 DRILL STOPS

GEN5™ IMPLANT CARRIER PACKAGING

The GEN5 implant is mounted on a platform specific, color-coded implant carrier.

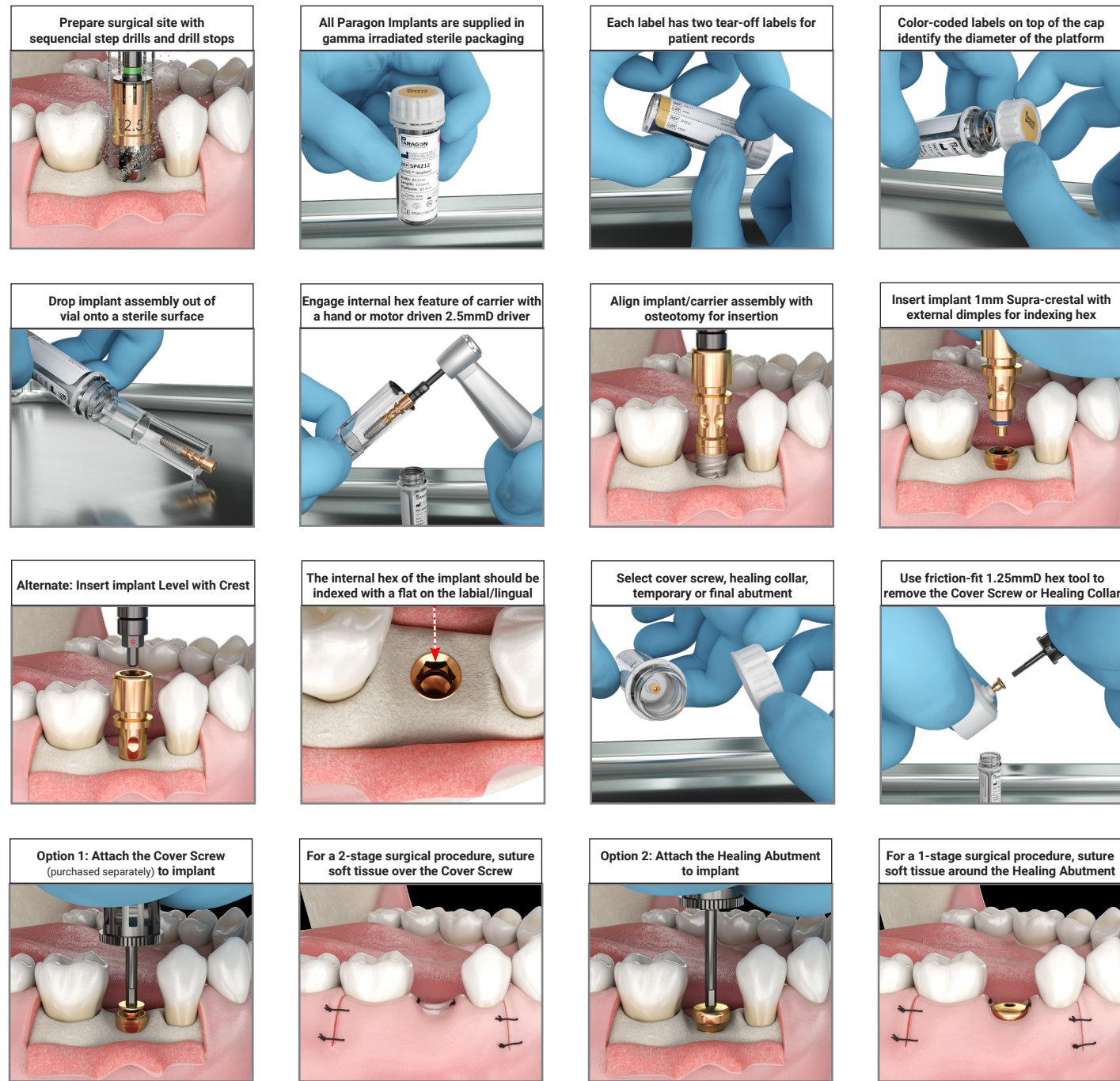

GEN5+™ IMPLANT CARRIER PACKAGING

The GEN5+ implant is mounted on a platform specific, color-coded implant carrier.

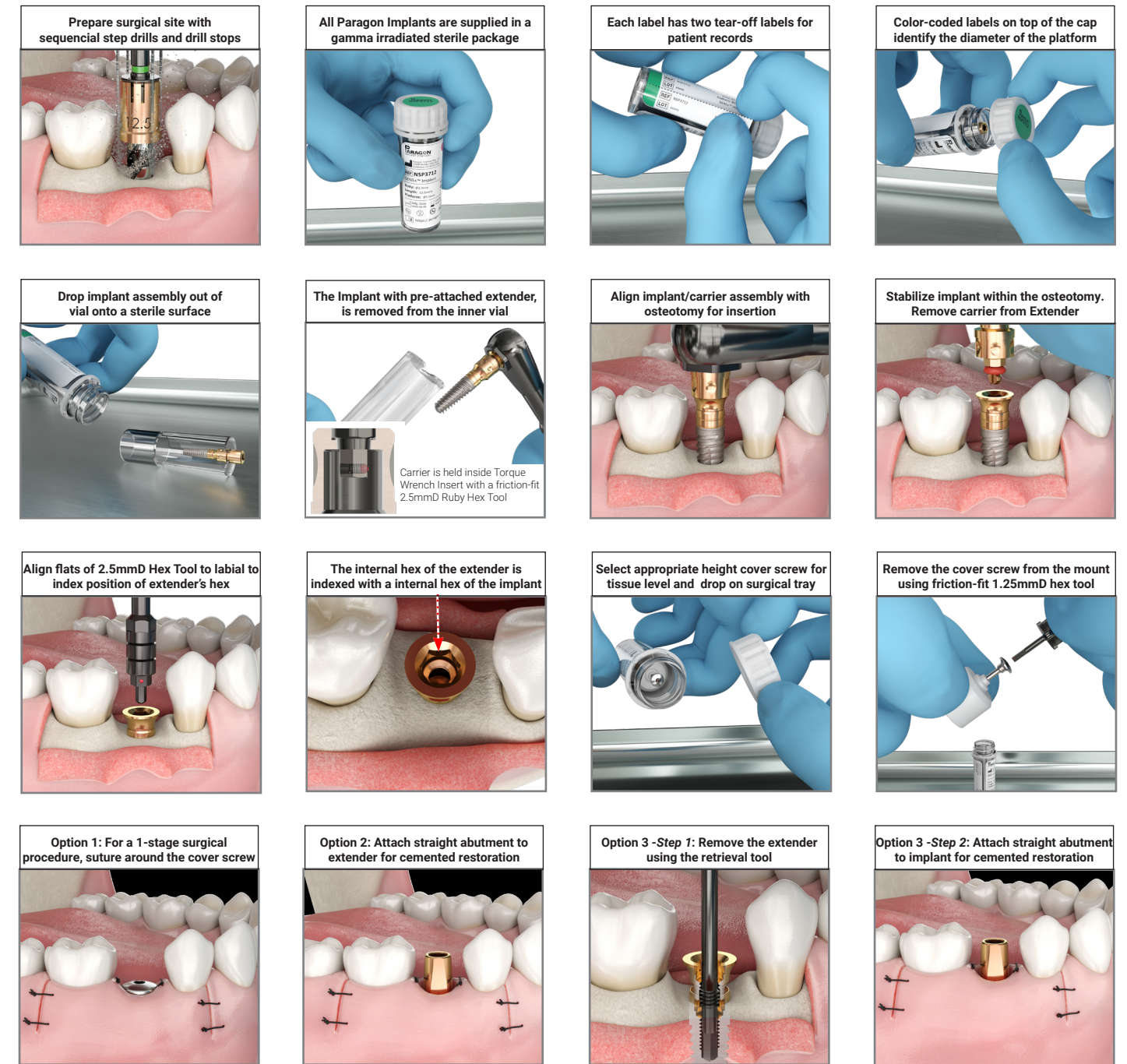

IMPLANT DIMENSIONS & LABELING
 GEN5™ & GEN5+™ IMPLANT
 IMPLANT CARRIER PACKAGING
 SELECTION CHART
 HEALING COLLARS & TRANSFERS
 ANALOGS & STRAIGHT/ ANGLED
 TEMPORARY & ASC
 MUA & COMPONENTS
 NIZLOC & SCREWS
 SURGICAL DRILLS & SEQUENCE
 STEP DRILL MARKINGS
 SURGICAL TRAY
 PROSTHETIC TRAY & TOOLING
 DRILL STOPS

SELECTION CHART

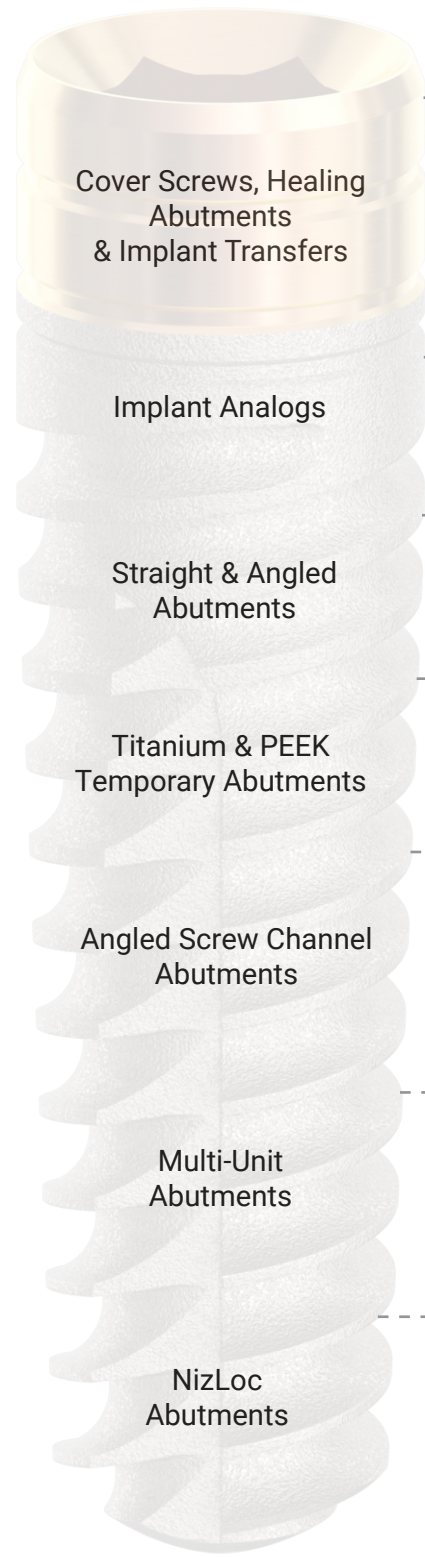

GEN5™ 3.5mmD Connection

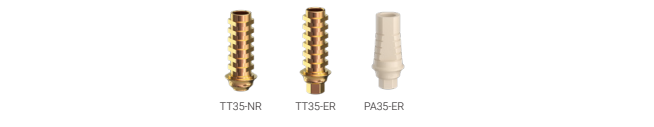

GEN5™ 4.5mmD Connection



Gen5+™





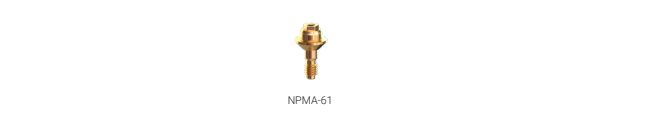
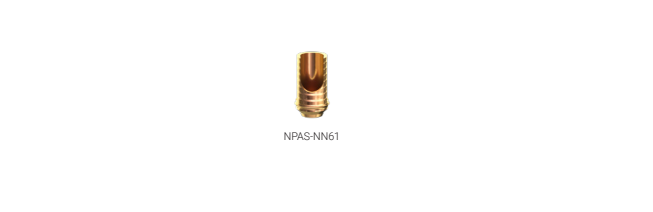





NizPlant™ Implant









IMPLANT DIMENSIONS & LABELING
GEN5™ & NIZPLANT™
IMPLANT CARRIER PACKAGING
SELECTION CHART
HEALING COLLARS & TRANSFERS
ANALOGS & STRAIGHT/ ANGLED
TEMPORARY & ASC
MUA & COMPONENTS
NIZLOC & SCREWS
SURGICAL DRILLS & SEQUENCE
STEP DRILL DEPTH MARKINGS
SURGICAL TRAY
PROSTHETIC TRAY & TOOLING
DRILL STOPS

COVER SCREWS & HEALING ABUTMENTS

Cover Screws	Code	Platform	Price
	CS35	3.5mmP	\$20.00
	CS45	4.5mmP	\$20.00
	CS57	5.7mmP	\$20.00

Healing Abutments 3.5	Code	Platform	Diameter	Length	Price
	HA35-3N	3.5mmP	3.7mmD	3.0mmL	\$30.00
	HA35-5N	3.5mmP	3.7mmD	5.0mmL	\$30.00
	HA35-3R	3.5mmP	4.7mmD	3.0mmL	\$30.00
	HA35-5R	3.5mmP	4.7mmD	5.0mmL	\$30.00
	HA35-3W	3.5mmP	5.7mmD	3.0mmL	\$30.00
	HA35-5W	3.5mmP	5.7mmD	5.0mmL	\$30.00

Healing Abutments 4.5	Code	Platform	Diameter	Length	Price
	HA45-3N	4.5mmP	4.7mmD	3.0mmL	\$30.00
	HA45-5N	4.5mmP	4.7mmD	5.0mmL	\$30.00
	HA45-3R	4.5mmP	5.7mmD	3.0mmL	\$30.00
	HA45-5R	4.5mmP	5.7mmD	5.0mmL	\$30.00

Extender Cover Screws	Code	Platform	Length	Price
	XTCS1	4.8mmP	1.0mmL	\$20.00
	XTCS2	4.8mmP	2.0mmL	\$20.00
	XTCS3	4.8mmP	3.0mmL	\$20.00

TRANSFERS

Engaging Closed-Tray Transfers (incl. UFS Screw)



Code	Platform	Diameter	Price
CT35-EN	3.5mmP	3.7mmD	\$40.00
CT35-ER	3.5mmP	4.7mmD	\$40.00
CT35-EW	3.5mmP	5.7mmD	\$40.00
CT45-EN	4.5mmP	4.7mmD	\$40.00
CT45-ER	4.5mmP	5.7mmD	\$40.00
Additional Screws:			
UFS (x2)			\$40.00
CTES			\$20.00

Engaging Open-Tray Transfers (incl. UFSL Screw)



Code	Platform	Diameter	Price
OT35-EN	3.5mmP	3.7mmD	\$40.00
OT35-ER	3.5mmP	4.7mmD	\$40.00
OT35-EW	3.5mmP	5.7mmD	\$40.00
OT45-EN	4.5mmP	4.7mmD	\$40.00
OT45-ER	4.5mmP	5.7mmD	\$40.00
Additional Screws:			
UFSL			\$20.00

Non-Engaging Open-Tray Transfers (incl. UFSL Screw)



Code	Platform	Diameter	Price
OT35-NN	3.5mmP	3.7mmD	\$40.00
OT35-NR	3.5mmP	4.7mmD	\$40.00
OT35-NW	3.5mmP	5.7mmD	\$40.00
OT45-NN	4.5mmP	4.7mmD	\$40.00
OT45-NR	4.5mmP	5.7mmD	\$40.00
Additional Screws:			
UFSL			\$20.00

Extender Transfers (incl. XTFSL or XTFS Screw)

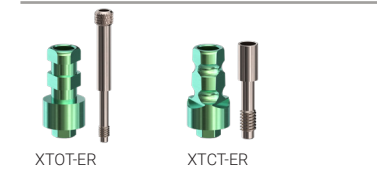



Code	Platform	Diameter	Price
XTOT-ER	4.8mmP	4.8mmD	\$40.00
XTCT-ER	4.8mmP	4.8mmD	\$40.00
Additional Screws:			
XTFSL (Open Tray)			\$20.00
XTFS (Closed Tray) (x2)			\$40.00

Nizplant Transfers (incl. UFS and NPFSL Screw)



Code	Platform	Diameter	Price
NPT-NR	3.2mmP	4.3mmD	\$40.00
Additional Screws:			
UFS (x2)			\$40.00
NPFSL			\$20.00

IMPLANT ANALOGS



Implant Analogs	Code	Platform	Price
	IA35 (x2)	3.5mmP	\$30.00
	IA45 (x2)	4.5mmP	\$30.00

IA35

IA45

Extender Analog	Code	Platform	Price
	XTA (x2)	4.8mmP	\$30.00

XTA

Nizplant Analogs	Code	Platform	Price
	NIA (x2)	3.9mmP	\$30.00
	NLA-N (x2)	3.9mmP	\$30.00
	NLA-W (x2)	3.9mmP	\$30.00

NIA

NLA-N

NLA-W

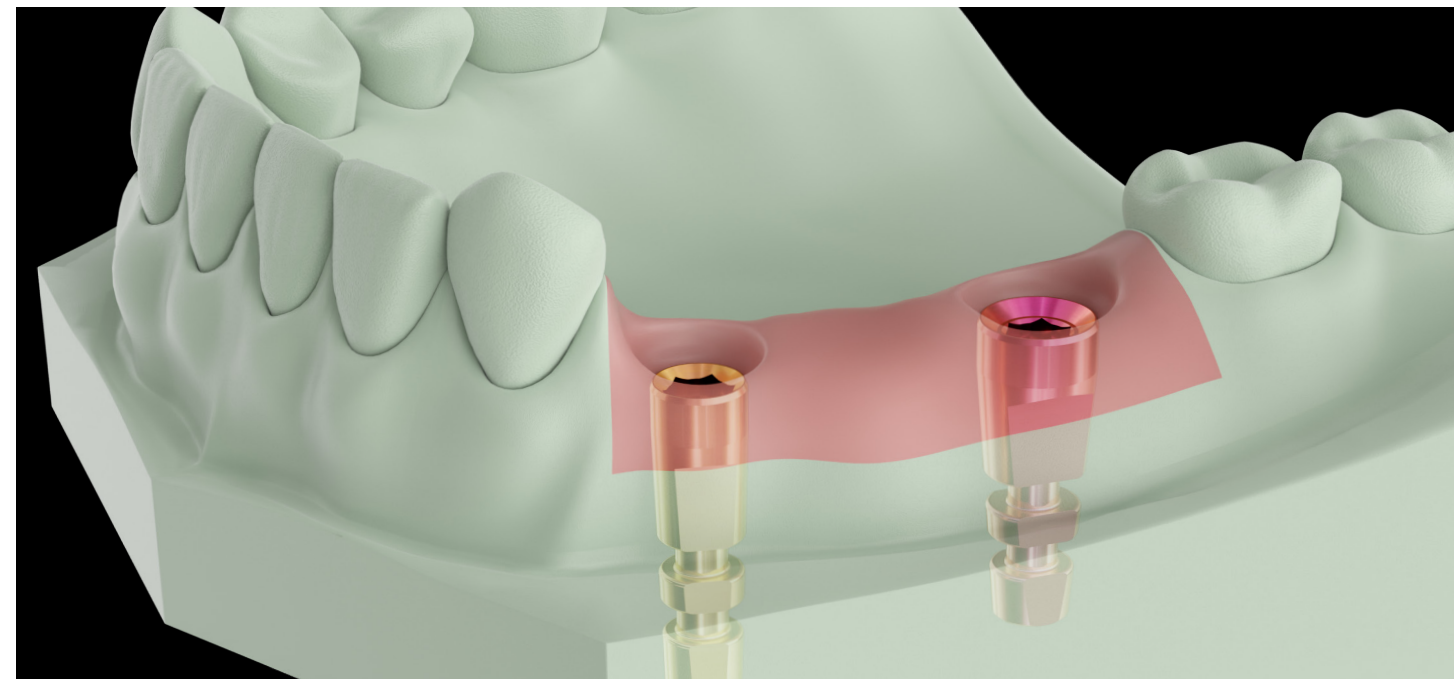

STRAIGHT & ANGLED CONTOUR ABUTMENTS

Straight Contour Abutments (incl. UFS Screw)



SA35-1N SA35-2N SA35-1R SA35-2R



SA45-1N SA45-2N SA45-1R SA45-2R

Code	Platform	Diameter	Length	Price
SA35-1N	3.5mmP	3.7mmD	1.0mmL	\$75.00
SA35-2N	3.5mmP	3.7mmD	2.0mmL	\$75.00
SA35-1R	3.5mmP	4.7mmD	1.0mmL	\$75.00
SA35-2R	3.5mmP	4.7mmD	2.0mmL	\$75.00
SA45-1N	4.5mmP	4.7mmD	1.0mmL	\$75.00
SA45-2N	4.5mmP	4.7mmD	2.0mmL	\$75.00
SA45-1R	4.5mmP	5.7mmD	1.0mmL	\$75.00
SA45-2R	4.5mmP	5.7mmD	2.0mmL	\$75.00

Additional Screws:

UFS (x2)	\$40.00
UFSS (x2)	\$40.00

15° Angled Abutments (incl. UFSXS Screw)



AA35-51 AA35-52



AA45-51 AA45-52



AA57-51 AA57-52

Code	Platform	Diameter	Length	Price
AA35-51	3.5mmP	4.7mmD	0.75mmL	\$90.00
AA35-52	3.5mmP	4.7mmD	2.0mmL	\$90.00
AA45-51	4.5mmP	4.7mmD	0.75mmL	\$90.00
AA45-52	4.5mmP	4.7mmD	2.0mmL	\$90.00
AA57-51	4.5mmP	5.7mmD	0.75mmL	\$90.00
AA57-52	4.5mmP	5.7mmD	2.0mmL	\$90.00

Additional Screws:

UFSXS (x2)	\$40.00
------------	---------

Extender Straight & Angled Abutments (incl. XTFS Screw or XTFSXS Screw)



XTSA-1R XTAA-51

Code	Platform	Diameter	Length	Price
XTSA-1R	4.8mmP	4.8mmD	0.25mmL	\$50.00
XTAA-51	4.8mmP	4.8mmD	0.25mmL	\$65.00

Additional Screws:

XTFS (x2)	\$40.00
XTFSS (x2)	\$40.00
XTFSXS (x2)	\$40.00

IMPLANT DIMENSIONS & LABELING
 GENS™ & NIZPLANT™
 IMPLANT CARRIER PACKAGING
 SELECTION CHART
 HEALING COLLARS & TRANSFERS
 ANALOGS & STRAIGHT / ANGLED
 TEMPORARY & ASC
 MUA & COMPONENTS
 NIZLOC & SCREWS
 SURGICAL DRILLS & SEQUENCE
 STEP DRILL DEPTH MARKINGS
 SURGICAL TRAY
 PROSTHETIC TOOLING
 DRILL STOPS

TITANIUM & PEEK TEMPORARY ABUTMENTS

Titanium Temporary Abutments (incl. UFS Screw)



Code	Platform	Diameter	Price
TT35-NR	3.5mmP	4.7mmD	\$50.00
TT35-ER	3.5mmP	4.7mmD	\$50.00
TT45-NR	4.5mmP	5.7mmD	\$50.00
TT45-ER	4.5mmP	5.7mmD	\$50.00

Additional Screws:

UFS (x2)	\$40.00
UFSS (x2)	\$40.00

Extender Temporary Abutments (incl. XTFS Screw)



Code	Platform	Diameter	Price
XTTT-EN	4.8mmP	4.8mmD	\$50.00

Additional Screws:

XTFS (x2)	\$40.00
-----------	---------

Nizplant Temporary Abutments (incl. UFS Screw)



Code	Platform	Diameter	Price
NPTT-NN	3.2mmP	4.2mmD	\$50.00

Additional Screws:

UFS (x2)	\$40.00
----------	---------

PEEK Temporary Abutments (incl. UFS Screw)



Code	Platform	Diameter	Price
PA35-ER	3.5mmP	4.7mmD	\$50.00
PA45-ER	4.5mmP	5.7mmD	\$50.00

Additional Screws:

UFS (x2)	\$40.00
UFSS (x2)	\$40.00
UFSL	\$20.00

Extender PEEK Temporary Abutment (incl. XTFS Screw)



Code	Platform	Diameter	Price
XTPA-ER	4.8mmP	4.8mmD	\$40.00

Additional Screws:

XTFS (x2)	\$40.00
XTFSS (x2)	\$40.00
XTFSL	\$20.00

ANGLED SCREW CHANNEL ABUTMENTS & COPING SETS

ASC Abutments 3.5 (incl. ASFSXS or ASFSS Screw)



Code	Platform	Diameter	Length	Price
AS35-EN61	3.5mmP	3.5mmD	0.5mmL	\$75.00
AS35-EN62	3.5mmP	3.5mmD	2.0mmL	\$75.00
AS35-NN61	3.5mmP	3.5mmD	0.5mmL	\$75.00
AS35-NN62	3.5mmP	3.5mmD	2.0mmL	\$75.00

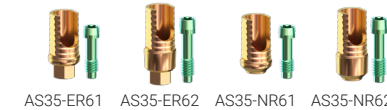

AS35-ER61	3.5mmP	3.6mmD	0.5mmL	\$75.00
AS35-ER62	3.5mmP	3.6mmD	2.0mmL	\$75.00
AS35-NR61	3.5mmP	3.6mmD	0.5mmL	\$75.00
AS35-NR62	3.5mmP	3.6mmD	2.0mmL	\$75.00



AS35-EW61	3.5mmP	3.7mmD	0.5mmL	\$75.00
AS35-EW62	3.5mmP	3.7mmD	2.0mmL	\$75.00
AS35-NW61	3.5mmP	3.7mmD	0.5mmL	\$75.00
AS35-NW62	3.5mmP	3.7mmD	2.0mmL	\$75.00

Additional Screws:

ASFSXS (x2) (for 61)	\$40.00
ASFSS (x2) (for 62)	\$40.00

ASC Abutments 4.5 (incl. ASFSXS or ASFSS Screw)

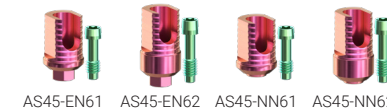

Code	Platform	Diameter	Length	Price
AS45-EN61	4.5mmP	3.7mmD	0.5mmL	\$75.00
AS45-EN62	4.5mmP	3.7mmD	2.0mmL	\$75.00
AS45-NN61	4.5mmP	3.7mmD	0.5mmL	\$75.00
AS45-NN62	4.5mmP	3.7mmD	2.0mmL	\$75.00

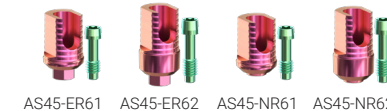

AS45-ER61	4.5mmP	4.7mmD	0.5mmL	\$75.00
AS45-ER62	4.5mmP	4.7mmD	2.0mmL	\$75.00
AS45-NR61	4.5mmP	4.7mmD	0.5mmL	\$75.00
AS45-NR62	4.5mmP	4.7mmD	2.0mmL	\$75.00

Additional Screws:

ASFSXS (x2) (for 61)	\$40.00
ASFSS (x2) (for 62)	\$40.00

Extender ASC Abutments (incl. XTAFS Screw)



Code	Platform	Diameter	Length	Price
XTAS-EN61	4.8mmP	4.8mmD	0.5mmL	\$50.00
XTAS-NN61	4.8mmP	4.8mmD	0.5mmL	\$50.00

Additional Screws:

XTAFS (x2)	\$40.00
------------	---------

Nizplant ASC Abutments (incl. ASFSXS Screw)



Code	Platform	Diameter	Length	Price
NPAS-NN61	4.7mmP	5.2mmD	0.5mmL	\$50.00

Additional Screws:

ASFSXS (x2)	\$40.00
-------------	---------

ASC Burn-out Coping Sets



Code	Diameter	Length	Price
AS37-EN60 (x2)	3.7mmD	5.0mmL	\$45.00
AS47-ER60 (x2)	4.7mmD	5.0mmL	\$45.00
AS52-EW60 (x2)	5.2mmD	5.0mmL	\$45.00
AS52-EN60 (x2)	5.2mmD	5.0mmL	\$45.00
AS57-ER60 (x2)	5.7mmD	5.0mmL	\$45.00



MULTI-UNIT ABUTMENTS

Multi-Unit Abutments 3.5	Code	Platform	Diameter	Length	Price
(*Incl. MACC)					
	MA35-11	3.5mmP	4.8mmD	1.0mmL	\$75.00
	MA35-12	3.5mmP	4.8mmD	2.0mmL	\$75.00
	MA35-13	3.5mmP	4.8mmD	3.0mmL	\$75.00
	MA35-14	3.5mmP	4.8mmD	4.0mmL	\$75.00
	MA35-15	3.5mmP	4.8mmD	5.0mmL	\$75.00
MA35-11 MA35-12 MA35-13 MA35-14 MA35-15					
Multi-Unit Abutments 4.5	Code	Platform	Diameter	Length	Price
(*Incl. MACC)					
	MA45-11	4.5mmP	4.8mmD	1.0mmL	\$75.00
	MA45-12	4.5mmP	4.8mmD	2.0mmL	\$75.00
	MA45-13	4.5mmP	4.8mmD	3.0mmL	\$75.00
	MA45-14	4.5mmP	4.8mmD	4.0mmL	\$75.00
	MA45-15	4.5mmP	4.8mmD	5.0mmL	\$75.00
MA45-11 MA45-12 MA45-13 MA45-14 MA45-15					
Multi-Unit Angled Abutments 3.5	Code	Platform	Diameter	Length	Price
(*Incl. MAFSXS Screw and MACC)					
	MA35-1-17	3.5mmP	5.3mmD	1.0/2.5mmL	\$90.00
	MA35-2-17	3.5mmP	5.3mmD	2.0/3.5mmL	\$90.00
	MA35-1-30	3.5mmP	7.0mmD	1.0/3.5mmL	\$90.00
	MA35-2-30	3.5mmP	7.0mmD	2.0/4.5mmL	\$90.00
MA35-1-17 MA35-2-17 MA35-1-30 MA35-2-30					
Additional Screws: MAFSXS (x2)					\$40.00
Multi-Unit Angled Abutments 4.5	Code	Platform	Diameter	Length	Price
(*Incl. MAFSXS Screw and MACC)					
	MA45-1-17	4.5mmP	4.8mmD	1.0/2.5mmL	\$90.00
	MA45-2-17	4.5mmP	4.8mmD	2.0/3.5mmL	\$90.00
	MA45-1-30	4.5mmP	4.8mmD	1.0/3.5mmL	\$90.00
	MA45-2-30	4.5mmP	4.8mmD	2.0/4.5mmL	\$90.00
MA45-1-17 MA45-2-17 MA45-1-30 MA45-2-30					
Additional Screws: MAFSXS (x2)					\$40.00
Extender Multi-Unit Abutments	Code	Platform	Diameter	Length	Price
(*Angled incl. XTMAFSXS Screw and MACC)					
	XTMA-60-4 (x4)	4.8mmP	4.8mmD	0mmL	\$100.00
	XTMA-61-4 (x4)	4.8mmP	4.8mmD	1.0mmL	\$100.00
	XTMA-62-4 (x4)	4.8mmP	4.8mmD	2.0mmL	\$100.00
	XTMA-17	4.8mmP	5.5mmD	1.5mmL	\$65.00
	XTMA-30	4.8mmP	7.0mmD	1.4mmL	\$65.00
XTMA-60-4 XTMA-61-4 XTMA-62-4 XTMA-17 XTMA-30					
Additional Screws: XTMAFSXS (x2)					\$40.00
Low Profile With 1-72 UNF Thread	Code	Platform	Diameter	Length	Price
	XTMAW-60-4 (x4)	4.8mmP	4.8mmD	0mmL	\$100.00
	XTMAW-61-4 (x4)	4.8mmP	4.8mmD	1.0mmL	\$100.00
	XTMAW-62-4 (x4)	4.8mmP	4.8mmD	2.0mmL	\$100.00
	XTMAW-63-4 (x4)	4.8mmP	4.8mmD	3.0mmL	\$100.00
	XTMAW-17	4.8mmP	5.5mmD	1.5mmL	\$65.00
	XTMAW-30	4.8mmP	7.0mmD	1.4mmL	\$65.00
XTMAW-60-4 XTMAW-61-4 XTMAW-62-4 XTMAW-63-4 XTMAW-17 XTMAW-30					
Additional Screws: XTMAFSXS (x2)					\$40.00
Nizplant Multi-Unit Abutments	Code	Platform	Diameter	Length	Price
(*Incl. MACC)					
	NPMA-61	3.2mmP	4.8mmD	1.0mmL	\$100.00
NPMA-61					

MULTI-UNIT ABUTMENTS PROSTHETIC COMPONENTS

Multi-Unit Abutment Transfers, Screws & Analog	Code	Platform	Diameter	Length	Price
(*Incl. MOTTTS or MCTTS Screw)					
	MOTT	4.8mmP	4.8mmD	9.0mmL	\$40.00
	MCTT	4.8mmP	4.8mmD	8.0mmL	\$40.00
	MAA (x2)	4.8mmP	4.8mmD	3.7mmL	\$30.00
MOTT MCTT MAA MOTTTS MCTTS					
Additional Screws: MOTTTS (x2)	M1.4		3.0mmD	12.1mmL	\$40.00
MCTTS (x2)	M1.4		2.1mmD	5.1mmL	\$40.00
Multi-Unit Abutment Coping & Healing Caps	Code	Platform	Diameter	Length	Price
(*Incl. MPS or ASMPS Screw)					
	MATTC	4.8mmP	4.8mmD	12mmL	\$50.00
	MAPLC	4.8mmP	4.8mmD	12mmL	\$40.00
	MAASC	4.8mmP	5.0mmD	8mmL	\$50.00
	MATIC	4.8mmP	5.8mmD	4.3mmL	\$50.00
	MASCC (x2)	4.8mmP	5.0mmD	10mmL	\$30.00
	MAPIC (x2)	1.4UNM	4.8mmD	N/A	\$35.00
MATTC MAPLC MAASC MATIC MASCC MAPIC					
Multi-Unit Abutment Pros. Screws & Guide Pin	Code	Platform	Diameter	Length	Price
	MPS (x2)	M1.4	2.1mmD	1.5mmL	\$40.00
	MPSL (x2)	M1.4	2.1mmD	2.5mmL	\$40.00
	MPS-4 (x4)	M1.4	2.1mmD	1.5mmL	\$70.00
	MPWS (x2)	M1.4	2.1mmD	2.5mmL	\$40.00
	MAGP (x4)	1.4UNM	2.35mmD	14.5mmL	\$80.00
	ASMPS (x2)	M1.4	2.1mmD	1.5mmL	\$40.00
MPS MPSL MPS-4 MPWS MAGP ASMPS					
Low Profile With 1.72mmD Screw Transfers, Screws & Analog	Code	Platform	Diameter	Length	Price
(*Incl. MOTTWS or MCTTWS Screw)					
	MOTTW	4.8mmP	4.8mmD	9.0mmL	\$40.00
	MCTTW	4.8mmP	4.8mmD	8mmL	\$40.00
	MAAW (x2)	4.8mmP	4.8mmD	3.7mmL	\$30.00
MOTTW MCTTW MAAW MOTTWS MCTTWS					
Additional Screws: MOTTWS (x2)	1-72UNF		3.0mmD	13.1mmL	\$40.00
MCTTWS (x2)	1-72UNF		2.1mmD	5.1mmL	\$40.00
Low Profile With 1.72mmD Screw Coping & Healing Caps	Code	Platform	Diameter	Length	Price
(*Incl. MPS or ASMPS Screw)					
	MATTCW	4.8mmP	4.8mmD	12mmL	\$50.00
	MAPLCW	4.8mmP	4.8mmD	12mmL	\$40.00
	MAASCW	4.8mmP	5.0mmD	8mmL	\$50.00
	MATICW	4.8mmP	5.8mmD	4.3mmL	\$50.00
	MASCCW (x2)	4.8mmP	5.0mmD	10mmL	\$30.00
	MAPICW (x2)	1.4UNM	4.8mmD	N/A	\$35.00
MATTCW MAPLCW MAASCW MATICW MASCCW MAPICW					
Low Profile With 1.72mmD Screw Pros. Screws & Guide Pin	Code	Platform	Diameter	Length	Price
	MPSW (x2)	1-72UNF	2.1mmD	2.5mmL	\$40.00
	MPSLW (x2)	1-72UNF	2.1mmD	1.5mmL	\$40.00
	MPSW-4 (x4)	1-72UNF	2.1mmD	1.5mmL	\$70.00
	MPWSW (x2)	1-72UNF	2.1mmD	15.2mmL	\$40.00
	MAGPW (x4)	1-72UNF	2.35mmD	14.5mmL	\$80.00
	ASMPSW (x2)	1-72UNF	2.1mmD	2.5mmL	\$40.00
MPSW MPSLW MPSW-4 MPWSW MAGPW ASMPSW					
Comfort Cap	Code	Description	Price		
	MACC-4 (x4)	Universal for all Multi-Unit Abutments	\$60.00		

IMPLANT DIMENSIONS & LABELING
 GENUS™ & NIZPLANT™
 IMPLANT CARRIER & PACKAGING
 SELECTION CHART
 HEALING COLLARS & TRANSFERS
 ANALOGS & STRAIGHT/ ANGLED
 TEMPORARY & ASC
 MUA & COMPONENTS
 NIZLOC & SCREWS
 SURGICAL DRILLS & SEQUENCE
 STEP DRILL DEPTH MARKINGS
 SURGICAL TRAY
 PROSTHETIC TRAY & TOOLING
 DRILL STOPS

NIZLOC ABUTMENTS, EXTENDERS & COMPONENTS

NizLoc Abutments 3.5	Code	Platform	Length	Price
	NL35-11	3.5mmP	1.0mmL	\$75.00
	NL35-12	3.5mmP	2.0mmL	\$75.00
	NL35-13	3.5mmP	3.0mmL	\$75.00
	NL35-14	3.5mmP	4.0mmL	\$75.00
	NL35-15	3.5mmP	5.0mmL	\$75.00

NizLoc Abutments 4.5	Code	Platform	Length	Price
	NL45-11	4.5mmP	1.0mmL	\$75.00
	NL45-12	4.5mmP	2.0mmL	\$75.00
	NL45-13	4.5mmP	3.0mmL	\$75.00
	NL45-14	4.5mmP	4.0mmL	\$75.00
	NL45-15	4.5mmP	5.0mmL	\$75.00

Extender NizLoc Abutments	Code	Platform	Length	Price
	XTNL-0	4.8mmP	0.25mmL	\$50.00
	XTNL-1	4.8mmP	1.25mmL	\$50.00
	XTNL-2	4.8mmP	2.25mmL	\$50.00

NizPlant NizLoc Abutments	Code	Platform	Diameter	Length	Price
	NPNL-2	3.2mmP	3.9mmD	2.0mmL	\$30.00

NizPlant Center Screw	Code	Description	Price
	NPCS (x2)	NizPlant Center Screw	\$40.00

NizLoc Components	Code	Platform	Diameter	Length	Price
	NLBS (x4)	N/A	6.2mmD	0.5mmL	\$16.00
	NLC-H (x4)	3.9mmP	5.5mmD	2.2mmL	\$60.00
	NLC-C (x4)	3.9mmP	4.8mmD	1.8mmL	\$24.00
	NLCE-P (x4)	3.9mmP	4.8mmD	1.8mmL	\$24.00
	NLC-L (x4)	3.9mmP	5.4mmD	1.9mmL	\$24.00
	NLIC (x2)	3.9mmP	5.4mmD	5.5mmL	\$24.00
	NLC-K (x2)	3.9mmP	5.5mmD	2.2mmL	\$80.00
	DLERL-P1	3.9mmP	5.5mmD	2.2mmL	
	DLERL-P2 (2 pk)	3.9mmP	5.5mmD	2.2mmL	
	DLRKL-P1	3.9mmP	5.5mmD	2.2mmL	
	DLRKL-P2 (2 pk)	3.9mmP	5.5mmD	2.2mmL	

FIXATION SCREWS

Universal Fixation Screws	Code	Description	Price
	UFSXS (x2)	Universal Fixation Screw, X-Short	\$40.00
	UFSS (x2)	Universal Fixation Screw, Short	\$40.00
	UFS (x2)	Universal Fixation Screw	\$40.00
	UFSL	Universal Fixation Screw Long	\$20.00
	UFSXL	Universal Fixation Screw X-Long	\$20.00
	XTFSXS (x2)	Extender Universal Fixation Screw, X-Short	\$40.00
	XTFSS (x2)	Extender Universal Fixation Screw, Short	\$40.00
	XTFS (x2)	Extender Universal Fixation Screw	\$40.00
	XTFSL	Extender Universal Fixation Screw, Long	\$20.00

NizPlant Fixation Screws	Code	Description	Price
	NPFSXS (x2)	NizPlant Fixation Screw, X-Short	\$40.00
	NPFS (x2)	NizPlant Fixation Screw	\$40.00
	NPFSL	NizPlant Fixation Screw, Long	\$20.00

Multi-Unit Angled Abutment Fixation Screw	Code	Description	Price
	MAFSXS (x2)	MUA Angled Fixation. Screw, X-Short	\$40.00
	XTMAFSXS (x2)	Extender MUA Angled Screw, X-Short	\$40.00

ASC Abutment Fixation Screw	Code	Description	Price
	ASFSXS (x2)	ASC Fixation Screw, X-Short	\$40.00
	ASFSS (x2)	ASC Fixation Screw, Short	\$40.00
	XTAFS (x2)	Extender ASC Fixation Screw	\$40.00

IMPLANT DIMENSIONS & LABELING
 GENUIS™ & NIZPLANT™
 IMPLANT CARRIER PACKAGING
 SELECTION CHART
 HEALING COLLARS & TRANSFERS
 ANALOGS & STRAIGHT/ ANGLED
 TEMPORARY & ASC
 MUA & COMPONENTS
 NIZLOC & SCREWS
 SURGICAL DRILLS & SEQUENCE
 STEP DRILL DEPTH MARKINGS
 SURGICAL TRAY
 PROSTHETIC TRAY & TOOLING
 DRILL STOPS

SURGICAL DRILLS & DRILL SEQUENCE

Code	Description	Price
SD1.8	Pilot Drill, Ø1.8mm, 7mmL	\$75.00
SD2.3	Step Drill 2.3/2.0, 7-14mmL, Long	\$75.00
SD2.8	Step Drill 2.8/2.3, 7-14mmL, Long	\$75.00
CD3.3	Crestal Drill, Ø3.3mm	\$75.00
SD3.4	Step Drill 3.4/2.8, 7-14mmL, Long	\$75.00
CD3.7	Crestal Drill, Ø3.7mm	\$75.00
SD3.8	Step Drill 3.8/3.4, 7-14mmL, Long	\$75.00
CD4.2	Crestal Drill, Ø4.2mm	\$75.00
SD4.4	Step Drill 4.4/3.8, 7-14mmL, Long	\$75.00
CD4.7	Crestal Drill, Ø4.7mm	\$75.00
SD4.8	Step Drill 4.8/4.4, 7-14mmL, Long	\$75.00
CD5.2	Crestal Drill, Ø5.2mm	\$75.00
SD5.1	Step Drill 5.1/4.8, 7-14mmL, Long	\$75.00
SD5.4	Step Drill 5.4/5.1, 7-14mmL, Long	\$75.00
CD5.7	Crestal Drill, Ø5.7mm	\$75.00

3.0mmD Implant

Pilot SD1.8, Soft Bone Final SD2.3/2.0, Dense Bone Final SD2.8/2.3

3.3mmD Implant

Pilot SD1.8, Soft Bone Final SD2.3/2.0, Soft Bone Final (Drill 1-2mm into osteotomy) SD2.3/2.0, Dense Bone Final (Drill to implant length - 1mm) SD2.8/2.3, Dense Bone Final (Drill to physical stop) CD3.3

3.7mmD Implant

Pilot SD1.8, Intermediate SD2.3/2.0, Soft Bone Final SD2.8/2.3, Dense Bone Final SD3.4/2.8, Optional Derise Bone CD3.7

4.2mmD Implant

Pilot SD1.8, Intermediate SD2.3/2.0, Optional SD2.8/2.3, Soft Bone Final SD3.4/2.8, Dense Bone Final SD3.8/3.4, Optional Derise Bone CD4.2

4.7mmD Implant

Pilot SD1.8, Intermediate SD2.3/2.0, Optional SD2.8/2.3, Intermediate SD3.4/2.8, Soft Bone Final SD3.8/3.4, Dense Bone Final SD4.4/3.8, Optional Derise Bone CD4.7

5.2mmD Implant

Pilot SD1.8, Intermediate SD2.3/2.0, Optional SD2.8/2.3, Intermediate SD3.4/2.8, Optional SD3.8/3.4, Soft Bone Final SD4.4/3.8, Dense Bone Final SD4.8/4.4, Optional Derise Bone CD5.2

5.7mmD Implant

Pilot SD1.8, Intermediate SD2.3/2.0, Optional SD2.8/2.3, Intermediate SD3.4/2.8, Optional SD3.8/3.4, Intermediate SD4.4/3.8, Optional SD4.8/4.4, Soft Bone Final SD5.1/4.8, Dense Bone Final SD5.4/5.1, Optional Derise Bone CD5.7

IMPLANT DIMENSIONS & LABELING
 GENUS™ & NIZPLANT™
 IMPLANT CARRIER PACKAGING
 SELECTION CHART
 HEALING COLLARS & TRANSFERS
 ANALOGS & STRAIGHT/ ANGLED
 TEMPORARY & ASC
 MUA & COMPONENTS
 NIZLOC & SCREWS
 SURGICAL DRILLS & SEQUENCE
 STEP DRILL DEPTH MARKINGS
 SURGICAL TRAY
 PROSTHETIC TRAY & TOOLING
 DRILL STOPS

STEP DRILL DEPTH MARKINGS & CRESTAL BONE DRILLS (OPTIONAL)

You can easily verify the depth marking line on DLC drills by aligning the point of the drill with the ruler on the surgical kit.

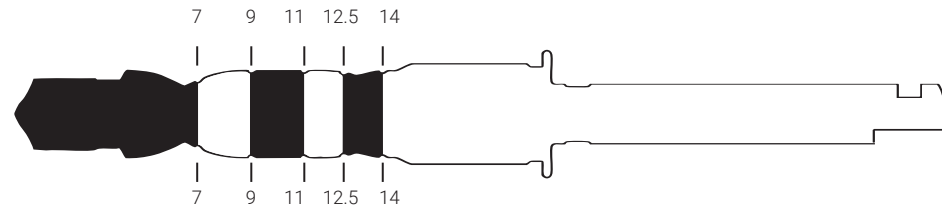

Use constant and profuse irrigation. During drilling, use an in-and-out motion. Move the drill up without stopping handpiece motor which allows the irrigation to flush away bone debris.

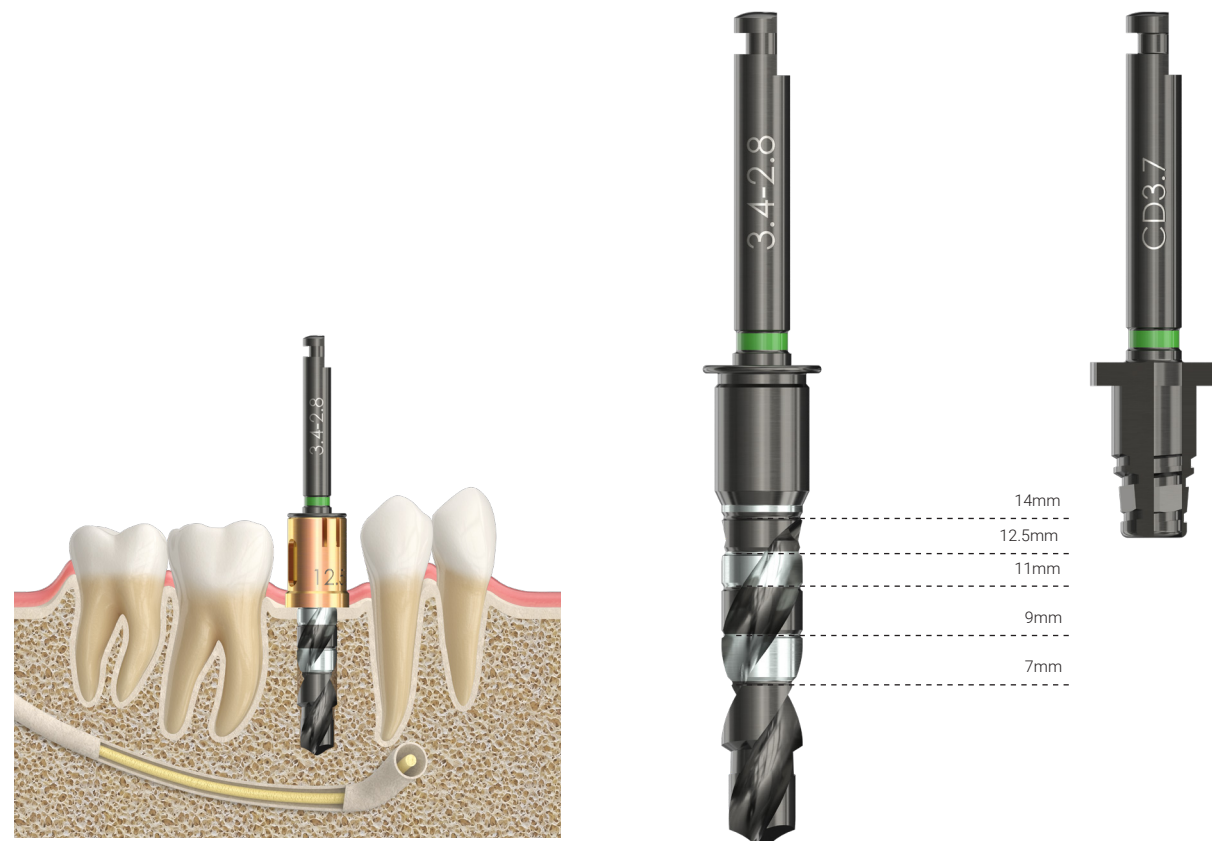

The Drill Stops provide the Implantologist control of what depth they prepare the osteotomy to, by providing a physical stop that fits over each drill.

BONE DRILL SEQUENCE

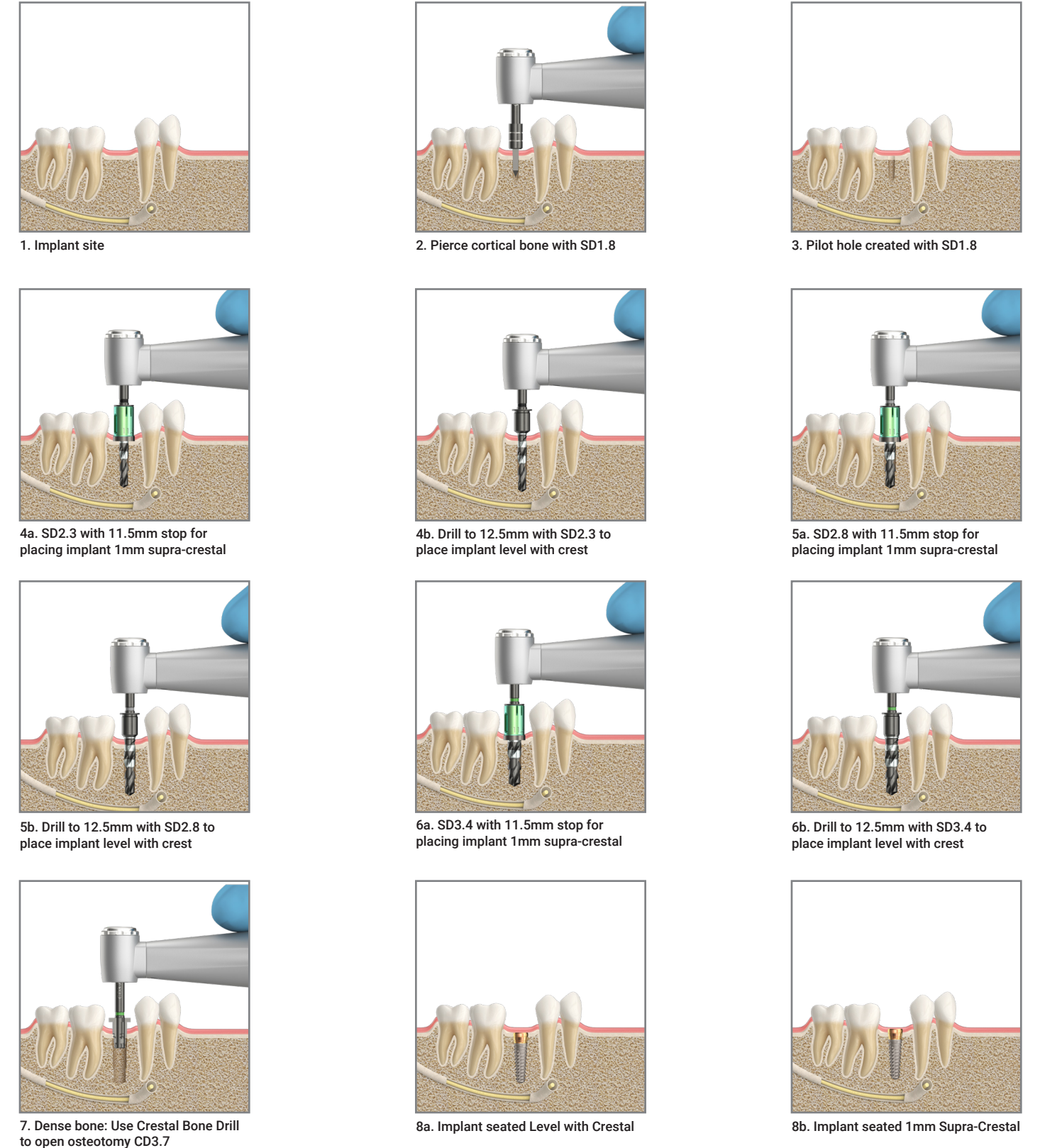

IMPLANT DIMENSIONS & LABELING
GENS™ & NIZPLANT™
IMPLANT CARRIER PACKAGING
SELECTION CHART
HEALING COLLARS & TRANSFERS
ANALOGS & STRAIGHT/ ANGLED
TEMPORARY & ASC
MUA & COMPONENTS
NIZLOC & SCREWS
SURGICAL DRILLS & SEQUENCE
STEP DRILL DEPTH MARKINGS
SURGICAL TRAY
PROSTHETIC TRAY & TOOLING
DRILL STOPS

SURGICAL TRAY

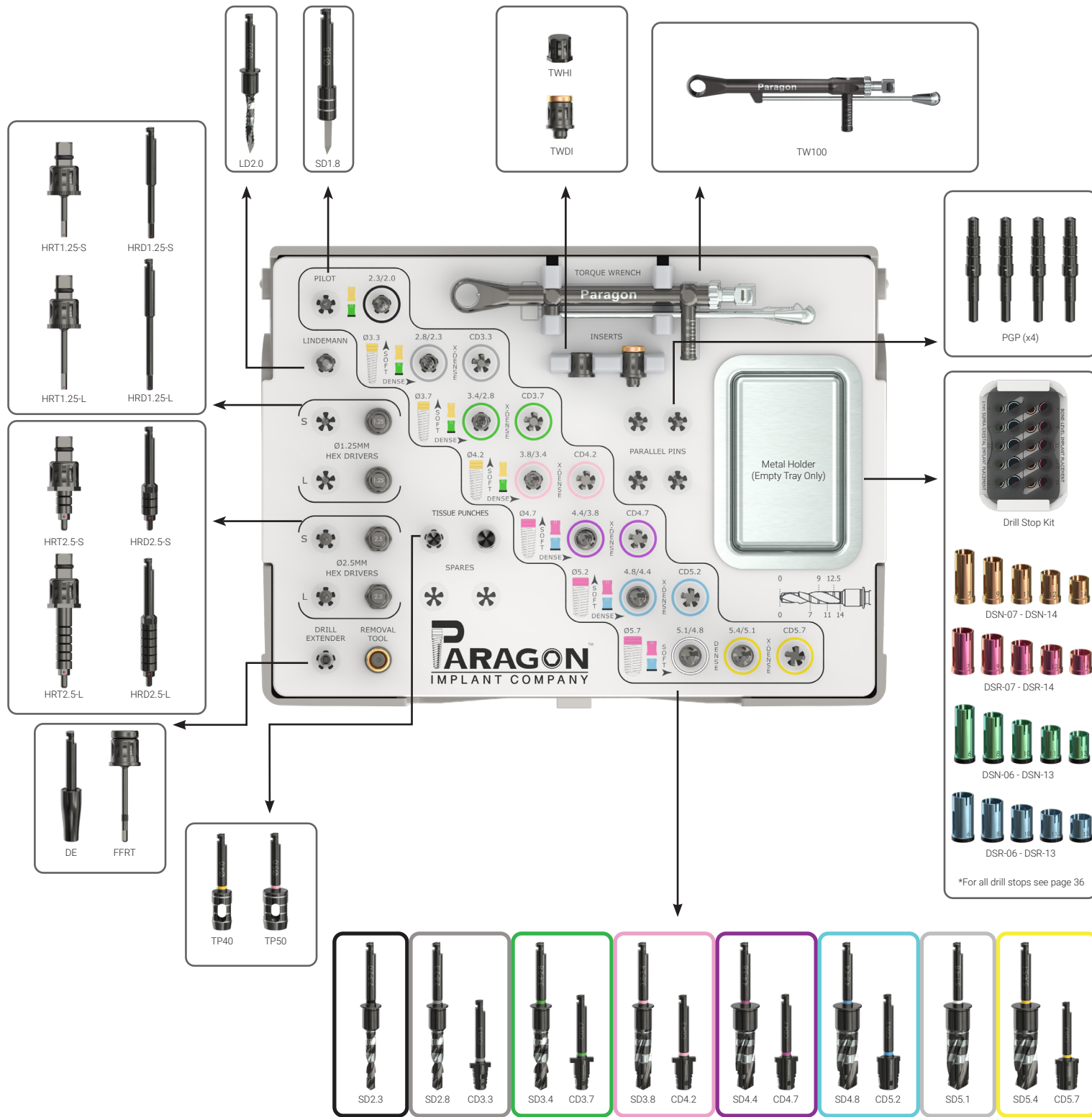

Surgical Tray Contents

Code	Description	Price
SK	Standard Surgical Kit Empty	\$285.00
BSK	Basic Surgical Kit	\$1,595.00
CSK	Complete Surgical Kit	\$2,430.00

Complete Surgical Kit Includes:

Drills		BSK	CSK
SD1.8	Ø1.8mm Starter Drill	X	X
SD2.3	Step Drill 2.3/2.0, 7-14mmL, Long	X	X
SD2.8	Step Drill 2.8/2.3, 7-14mmL, Long	X	X
SD3.4	Step Drill 3.4/2.8, 7-14mmL, Long	X	X
SD3.8	Step Drill 3.8/3.4, 7-14mmL, Long	X	X
SD4.4	Step Drill 4.4/3.8, 7-14mmL, Long	X	X
SD4.8	Step Drill 4.8/4.4, 7-14mmL, Long	X	X
SD5.1	Step Drill 5.1/4.8, 7-14mmL, Long	X	X
SD5.4	Step Drill 5.4/4.8, 7-14mmL, Long	X	X
CD3.3	Crestal Drill, Ø3.3mm	X	X
CD3.7	Crestal Drill, Ø3.7mm	X	X
CD4.2	Crestal Drill, Ø4.2mm	X	X
CD4.7	Crestal Drill, Ø4.7mm	X	X
CD5.2	Crestal Drill, Ø5.2mm	X	X
CD5.7	Crestal Drill, Ø5.7mm	X	X





Tools

PGP	Paralleling Guide Pin (x4)	\$50.00	X	X
DE	Drill Extender, 16mL	\$75.00	X	X
FFRT	Removal Tool for Friction-Fit Abutments	\$40.00		X
HRT1.25-S/HRT1.25-L	1.25mm Hex Tool, Short/Long	\$40.00	Long	X
HRD1.25-S/HRD1.25-L	1.25mm Latch Hex Drill, Short/Long	\$40.00	Long	X
HRT2.5-S/HRT2.5-L	2.5mm Hex Tool, Short/Long	\$40.00	Long	X
HRD2.5-S/HRD2.5-L	2.5mm Latch Hex Drill, Short/Long	\$40.00	Long	X
TP40	Tissue Punch, 4.0mmD	\$75.00		X
TP50	Tissue Punch, 5.0mmD	\$75.00		X
TW100	Torque Wrench	\$220.00	X	X
TWHI	Torque Wrench Insert with 2.5mmD Hex	\$40.00		X
TWDI	Torque Wrench Insert for Drill Latch Connection	\$40.00	X	X
DSK	Drill Stop Kit (Incl. all 20 drill stops)	\$400.00		X
Metal Tray		N/A	X	

*For all drill stops see page 36

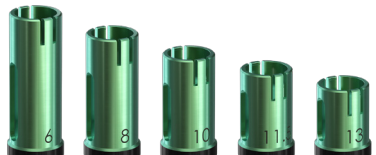
IMPLANT DIMENSIONS & LABELING
 GENUIS™ & NIZLOC™
 IMPLANT CARRIER PACKAGING
 SELECTION CHART
 HEALING COLLARS & TRANSFERS
 ANALOGS & ANGLED
 TEMPORARY & ASC
 MUA & COMPONENTS
 NIZLOC & SCREWS
 SURGICAL DRILLS & SEQUENCE
 STEP DRILL DEPTH MARKINGS
 SURGICAL TRAY & TOOLING
 DRILL STOPS

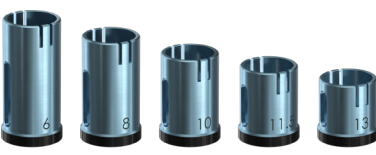
DRILL STOPS

Drill Stops	Code	Description	Price
Bone Level <= 3.8mmD	DSN-07	Drill Stop Narrow- 2.3 -3.8mmD for 7mmL Imp.	\$15.00
	DSN-09	Drill Stop Narrow- 2.3 -3.8mmD for 9mmL Imp.	\$15.00
	DSN-11	Drill Stop Narrow- 2.3 -3.8mmD for 11mmL Imp.	\$15.00
	DSN-12	Drill Stop Narrow- 2.3 -3.8mmD for 12.5mmL Imp.	\$15.00
DSN-07 - DSN-14	DSN-14	Drill Stop Narrow- 2.3 -3.8mmD for 14mmL Imp.	\$15.00
+1mm Level <= 3.8mmD	DSN-06L	Drill Stop Narrow- 2.3 -3.8mmD for 6mmL Imp.	\$15.00
	DSN-08L	Drill Stop Narrow- 2.3 -3.8mmD for 8mmL Imp.	\$15.00
	DSN-10L	Drill Stop Narrow- 2.3 -3.8mmD for 10mmL Imp.	\$15.00
	DSN-11L	Drill Stop Narrow- 2.3 -3.8mmD for 11.5mmL Imp.	\$15.00
DSN-06L - DSN-13L	DSN-13L	Drill Stop Narrow- 2.3 -3.8mmD for 13mmL Imp.	\$15.00
Bone Level => 4.4mmD	DSR-07	Drill Stop Regular- 4.4-5.4mmD for 7mmL Imp.	\$15.00
	DSR-09	Drill Stop Regular- 4.4-5.4mmD or 9mmL Imp.	\$15.00
	DSR-11	Drill Stop Regular- 4.4-5.4mmD for 11mmL Imp.	\$15.00
	DSR-12	Drill Stop Regular- 4.4-5.4mmD for 12.5mmL Imp.	\$15.00
DSR-07 - DSR-14	DSR-14	Drill Stop Regular- 4.4-5.4mmD for 14mmL Imp.	\$15.00
+1mm Level => 4.4mmD	DSR-06L	Drill Stop Regular- 4.4-5.4mmD for 6mmL Imp.	\$15.00
	DSR-08L	Drill Stop Regular- 4.4-5.4mmD for 8mmL Imp.	\$15.00
	DSR-10L	Drill Stop Regular- 4.4-5.4mmD for 10mmL Imp.	\$15.00
	DSR-11L	Drill Stop Regular- 4.4-5.4mmD for 11.5mmL Imp.	\$15.00
DSR-06L - DSR-13L	DSR-13L	Drill Stop Regular- 4.4-5.4mmD for 13mmL Imp.	\$15.00
	DSK	Drill Stop Kit (Incl. all 20 drill stops)	\$400.00

DRILL STOP SEQUENCE AND PLACEMENT



1. Drill Stop Kit is seated in the Surgical Kit

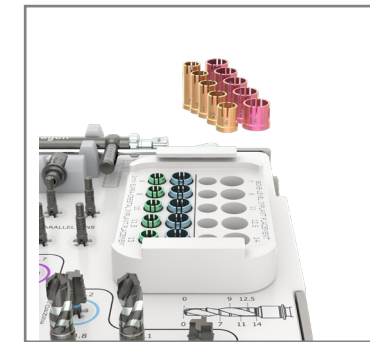

2. The Bone-level drill stops: gold stops are narrow, and pink stops are wide

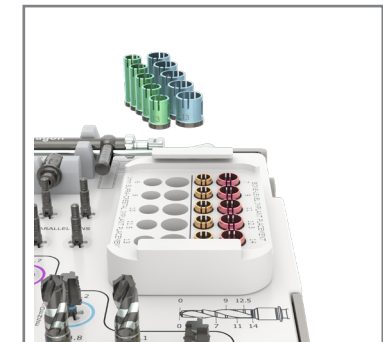

3. The 1mm supracrestal drill stops: green stops are narrow, and blue stops are regular (with black band on bottom)

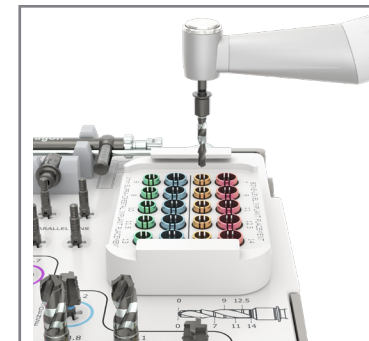

4. Handpiece with drill is shown floating above the Drill Stop kit

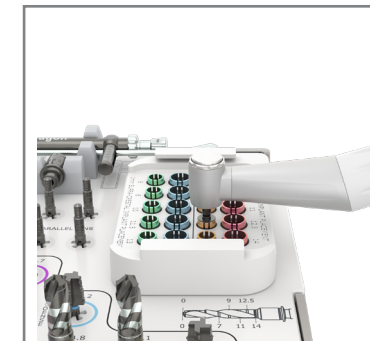

5. Drill is inserted into the selected drill stop.

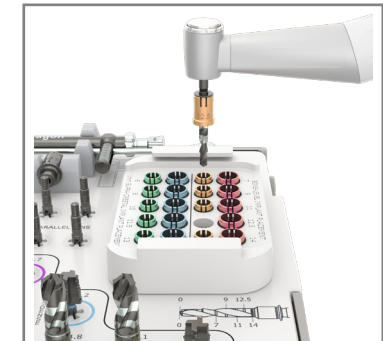

6. Handpiece lifted with the drill stop now attached to the drill.

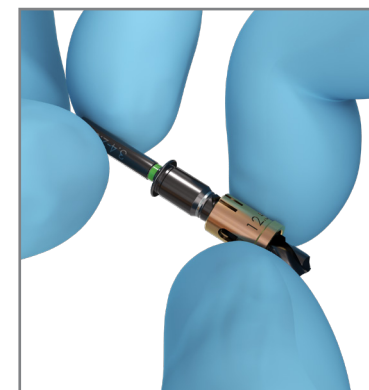

Placing the drill stop on the drill



The Gold and Magenta Drill Stops create a socket depth equal to the overall length of the implant selected for placement bone level

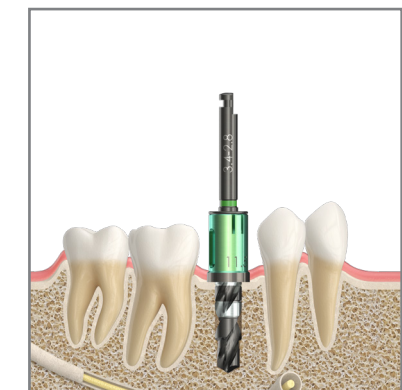

The Green and Blue Drill Stops create a socket depth 1mm short of the overall length of the implant selected for placement 1mm Supra-crestal



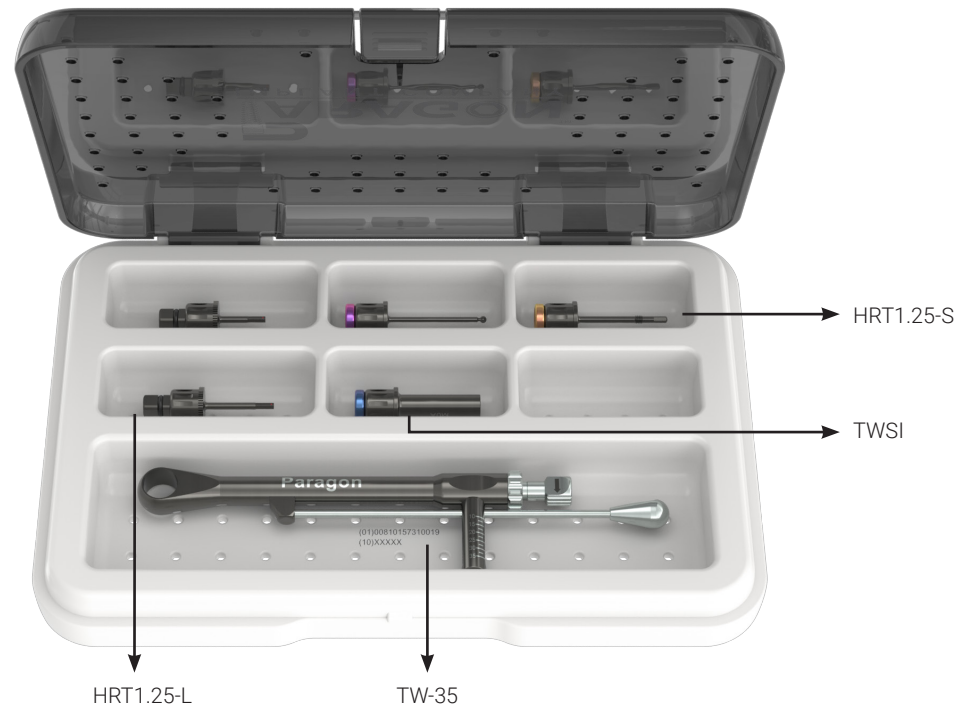

PROSTHETIC TRAY













Tools for Prosthetic Tray (optional)

Code	Description	Price
PKE	Prosthetic Kit Empty	\$100.00
TW-35	Variable Setting Torque Wrench, 35Ncm	\$220.00
HRT1.25-S	1.25mmD Ruby Hex Tool, Short	\$35.00
HRT1.25-L	1.25mmD Ruby Hex Tool, Long	\$35.00
HRT1.25-XL	1.25mmD Ruby Hex Tool, X-Long	\$35.00
ASCWD-S	ASC Wrench Driver, Short 24mmL	\$40.00
ASCWD-L	ASC Wrench Driver, Long 29mmL	\$40.00
ASCWD-XL	ASC Wrench Driver, X-Long 34mmL	\$40.00
ASCMD-S	ASC Manual Driver, Short 20mmL	\$40.00
ASCMD-L	ASC Manual Driver, Long 25mmL	\$40.00
ASCMD-XL	ASC Manual Driver, X-Long 30mmL	\$40.00
MAMD-S	MUA Manual Driver, Short 22mmL	\$40.00
MAMD-L	MUA Manual Driver, Long 26mmL	\$40.00
MAWD-S	MUA Wrench Driver, Short 22mmL	\$40.00
MAWD-L	MUA Wrench Driver, Long 26mmL	\$40.00
MAWD-XL	MUA Wrench Driver, X-Long 30mmL	\$40.00

TOOLING

Kits	Code	Description	Price
	SSK	Standard Surgical Kit Empty	\$285.00
	CSK	Complete Surgical Kit incl. Drill Stop Kit	\$2,430.00
	PKE	Prosthetic Kit Empty	\$100.00
	DSK	Drill Stop Kit	\$400.00

Hex Tools	Code	Description	Price
	HRT1.25-S	1.25mmD Ruby Hex Tool, Short	\$40.00
	HRT1.25-L	1.25mmD Ruby Hex Tool, Long	\$40.00
	HRT1.25-XL	1.25mmD Ruby Hex Tool, X-Long	\$40.00
	HRT2.5-S	2.5mmD Manual Ruby Hex Tool, Short	\$40.00
	HRT2.5-L	2.5mmD Manual Ruby Hex Tool, Long	\$40.00
	HRT2.5-XL	2.5mmD Manual Ruby Hex Tool, X-Long	\$40.00

Hex Drills	Code	Description	Price
	HRD1.25-S	1.25mmD Latch Ruby Hex Drill, Short	\$40.00
	HRD1.25-L	1.25mmD Latch Ruby Hex Drill, Long	\$40.00
	HRD2.5-S	2.5mmD Latch Ruby Hex Drill, Short	\$40.00
	HRD2.5-L	2.5mmD Latch Ruby Hex Drill, Long	\$40.00

NizPlant Insertion Tool	Code	Description	Price
	NPIT-S	2.5mmD NizPlant Insertion Tool, Short	\$40.00

IMPLANT DIMENSIONS & LABELING
 GEN5™ & NIZPLANT™
 IMPLANT CARRIER PACKAGING
 SELECTION CHART
 HEALING COLLARS & TRANSFERS
 ANALOGS & STRAIGHT/ ANGLED
 TEMPORARY & ASC
 MUA & COMPONENTS
 NIZLOC & SCREWS
 SURGICAL DRILLS & SEQUENCE
 STEP DRILL DEPTH MARKINGS
 SURGICAL TRAY
 PROSTHETIC TRAY & TOOLING
 DRILL STOPS

TOOLING CONTINUED

Angle Measuring Guide

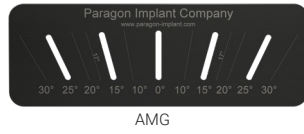

Code

AMG

Description

Angle Measuring Guide

Price

\$25.00

Ancillary Instruments

Code

Description

Price



TW-35

Variable Setting Torque Wrench, 35Ncm

\$220.00



TW-100

Variable Setting Torque Wrench, 100Ncm

\$220.00



TWSI

Torque Wrench Insert for 4mm x 4mm square components

\$40.00



TWDI

Torque Wrench Insert for Drill Latch Connection

\$40.00



TWHI

Torque Wrench Insert with 2.5mmD Hex

\$40.00

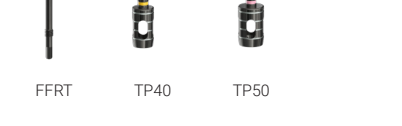

REXT

Ratchet and Hand Wrench Extender

\$40.00



SD1.8

1.8mmD Starter Drill with 7mmL stop

\$75.00



LD2.0

2.0mmD Lindemann Drill

\$75.00



PGP

Paralleling Guide Pin

\$15.00



DE

Drill Extender, 16mL

\$75.00

FFRT

Removal Tool for Friction-Fit Abutments

\$40.00

TP40

Tissue Punch, 4.0mmD

\$75.00

TP50

Tissue Punch, 5.0mmD

\$75.00

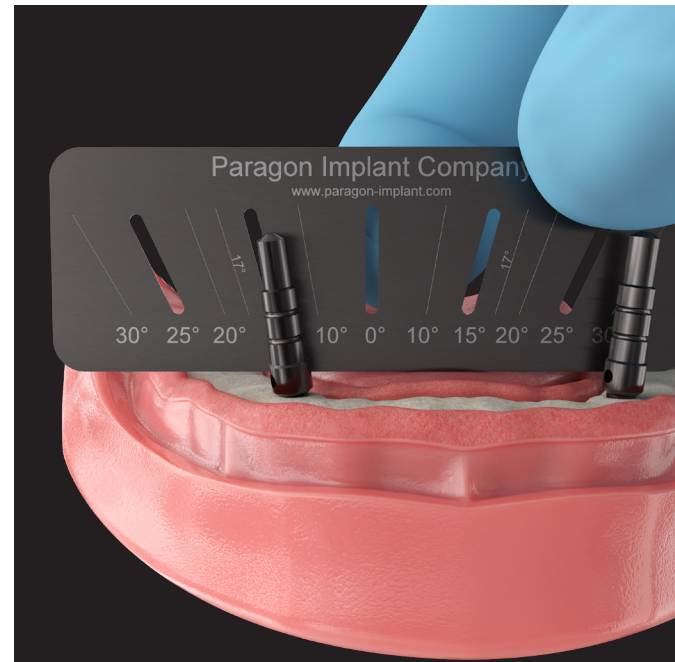

TOOLING CONTINUED

ASC Tools

Code

Description

Price



ASCWD-S

ASC Wrench Driver, Short 24mmL

\$40.00

ASCWD-L

ASC Wrench Driver, Long 29mmL

\$40.00

ASCWD-XL

ASC Wrench Driver, X-Long 34mmL

\$40.00



ASCMD-S

ASC Manual Driver, Short 20mmL

\$40.00

ASCMD-L

ASC Manual Driver, Long 25mmL

\$40.00

ASCMD-XL

ASC Manual Driver, X-Long 30mmL

\$40.00



ASCLD-S

ASC Latch Driver, Short 27mmL

\$40.00

ASCLD-L

ASC Latch Driver, Long 32mmL

\$40.00

ASCLD-XL

ASC Latch Driver, X-Long 37mmL

\$40.00

MUA Tools

Code

Description

Price



MAMD-S

MUA Manual Driver, Short 22mmL

\$40.00

MAMD-L

MUA Manual Driver, Long 26mmL

\$40.00

MAWD-S

MUA Wrench Driver, Short 22mmL

\$40.00

MAWD-L

MUA Wrench Driver, Long 26mmL

\$40.00



MAWD-XL

MUA Wrench Driver, X-Long 30mmL

\$40.00

MALD-S

MUA Latch Driver, Short 20mmL

\$40.00

MALD-L

MUA Latch Driver, Long 24mmL

\$40.00



- Placement bone level or supra-crestal
- Drill stops in two heights, inserted through sleeves in surgical guides
- Eliminates need for surgical guide keys or length specific drills



40+ YEARS OF INNOVATION

36 PATENTS - 3 SPECIFIC TO THE PARAGON™ SYSTEM



WATCH DR. NIZNICK'S 1.5 HOUR LECTURE ON THE DESIGN ADVANTAGES OF THE NEXT GENERATION OF IMPLANT SYSTEMS!

24/7 LIGHTS OUT MANUFACTURING

GERALD NIZNICK, DMD, MSD



Manufacturing
 27030 Malibu Hills Road
 Calabasas, CA 91301
 818.475.4675

Distribution and Customer Service
 8840 W.Russell Road Ste.205
 Las Vegas, NV 89148
 702.726.7271